



*Easier Operation
Better Fixation*



Get Better

Expertise and enthusiasm can be perfectly combined into a top-notch medical engineering brand!

As Dunitech, we contribute to the development of health services by providing superior technology products at competitive costs.

We envision a socially conscious business environment serving the health industry and patients get better.

Dunitech branded products are designed and engineered to keep our promise;

Easier Operation
Better Fixation

Dunitech Solutions for
Fractures
of the Femur and Tibia



Value Proposition

As Dunitech, we value patients, and we are eager to develop and improve medical devices that support professionals.

"Get better" is a mission and a call for us in delivering innovative solutions for the orthopedic community.

Manufacturing & Quality

Dunitech controls the manufacturing process every step of the way to warrant the excellent quality with high efficiency and minimum carbon footprint.

Research & Development

Our engineering team works closely with reputable universities and research hospitals to improve our devices. The experience of healthcare professionals and the needs of their patients are in the center of Dunitech's product development.

Sales & Marketing

Our highly skilled sales and training teams always have customer satisfaction as their top priority. Get in touch with us for any information you may need. We won't keep you awaiting a reply.

Dunitech Claw Technology

Dunitech leads innovational systems, and aims to supply options for the surgeons to excel at their expertise. Claws are a novelty solution on distal locking systems designed to support the orthopedic trauma community.

Claws are titanium pins that act as anchors to provide a stable fixation, as well as other superior operative parameters.



- ✓ The Claws are made from titanium, and mechanically deploy from within the nail and lag screw.
- ✓ The Claws penetrate through the cancellous bone, and anchor the nails and lag screw in the cortical bone.



We focus on operative parameters that are vital for to success of the fracture treatment.

Dunitech's innovative devices allow healthcare professionals to reduce surgical time as well as the risk of pre - and postoperative complications.

By eliminating the distal incisions, the Claws significantly reduce the radiation exposure and blood loss.



- ✓ *Increased stability*
- ✓ *Shorter operative time*
- ✓ *Lower radiation exposure*
- ✓ *Fewer incisions*
- ✓ *Easy revision*
- ✓ *No free-hand locking*
- ✓ *Less bone removal*

Claws in Action

The Claws' performance was evaluated using a series of biomechanical tests.¹

All Claws were **successfully retracted** after every test.

Claws are **reliably retractable!**

Conventional systems are subjected to screw breakage, screw headwear and drill bit breakage that may prevent the nail to be removed. Dunitech Claws are deployed within the nails from precise holes in a tight fit, preventing empty spaces for bone ingrowth.

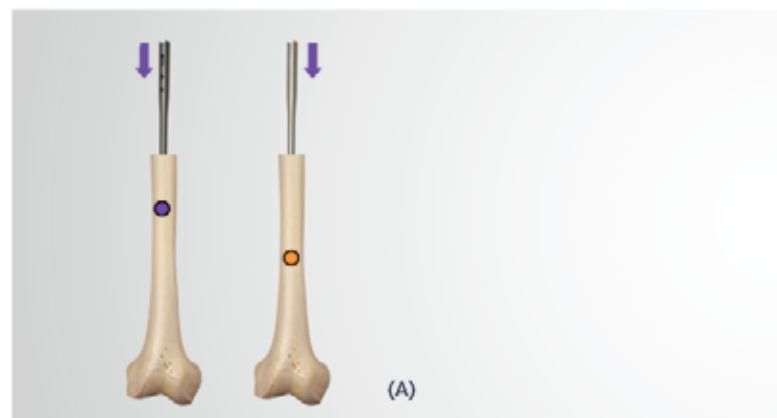
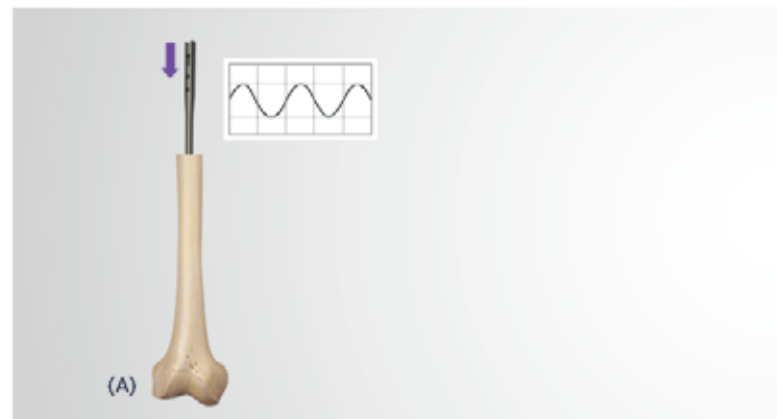
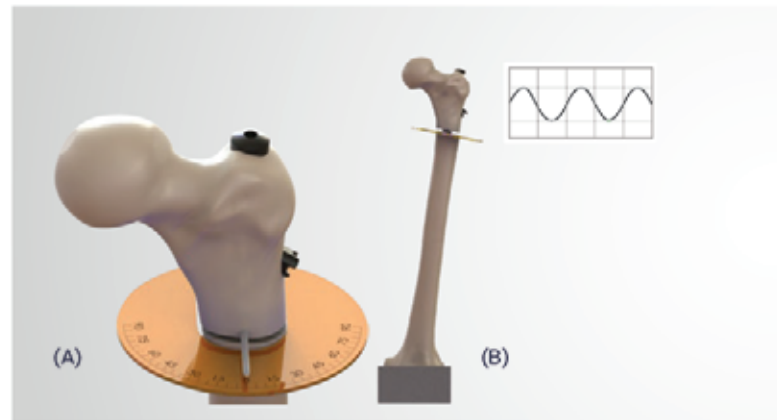

1. The studies presented in the subsequent pages were performed at the following labs; Knight Mechanical Testing, 60168 Highview Drive, Fort Wayne, IN 46818 and Phillip Spiegel Orthopaedic Research Laboratory, Foundation of Orthopaedic Research and Education, 13020 N. Telecom Parkway, Tampa, FL 33637

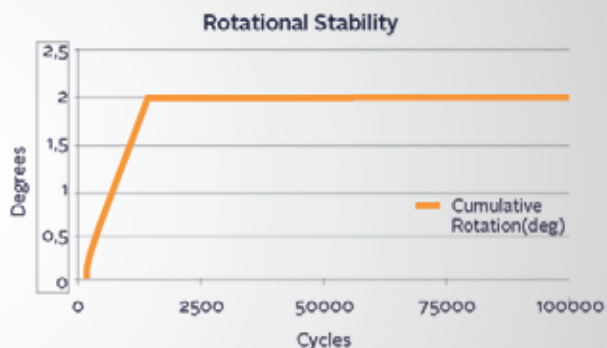

Rotational Stability

In unstable subtrochanteric fractures Claws provide superior rotational stability. After 10,000 cycles, the nail settled in and remained fixed until 100,000 cycles.

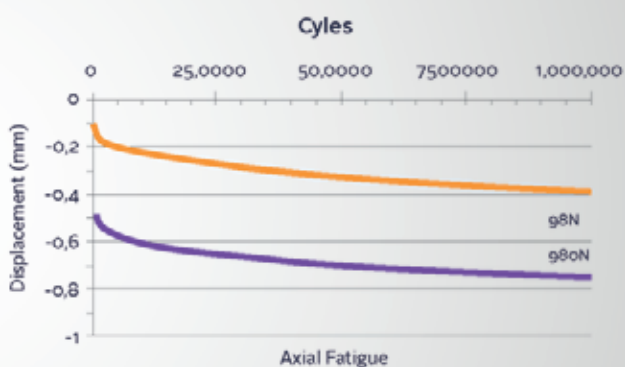

Claws Axial Fatigue Strength

The average displacement observed at 1 million cycles was 0.74 mm.

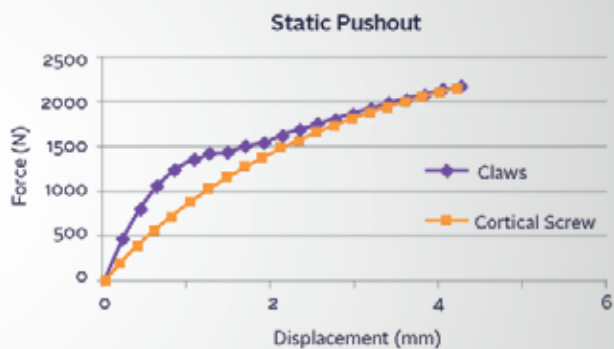

Claw Axial Static Strength

Claws resist to a higher force for a given displacement, compared to conventional stainless steel screws.



Get Better Stability!

Claws have 6 points of contact with the cortical bone. The load is shared between those points, increasing the implant's stability, and preventing secondary fractures and malunions.

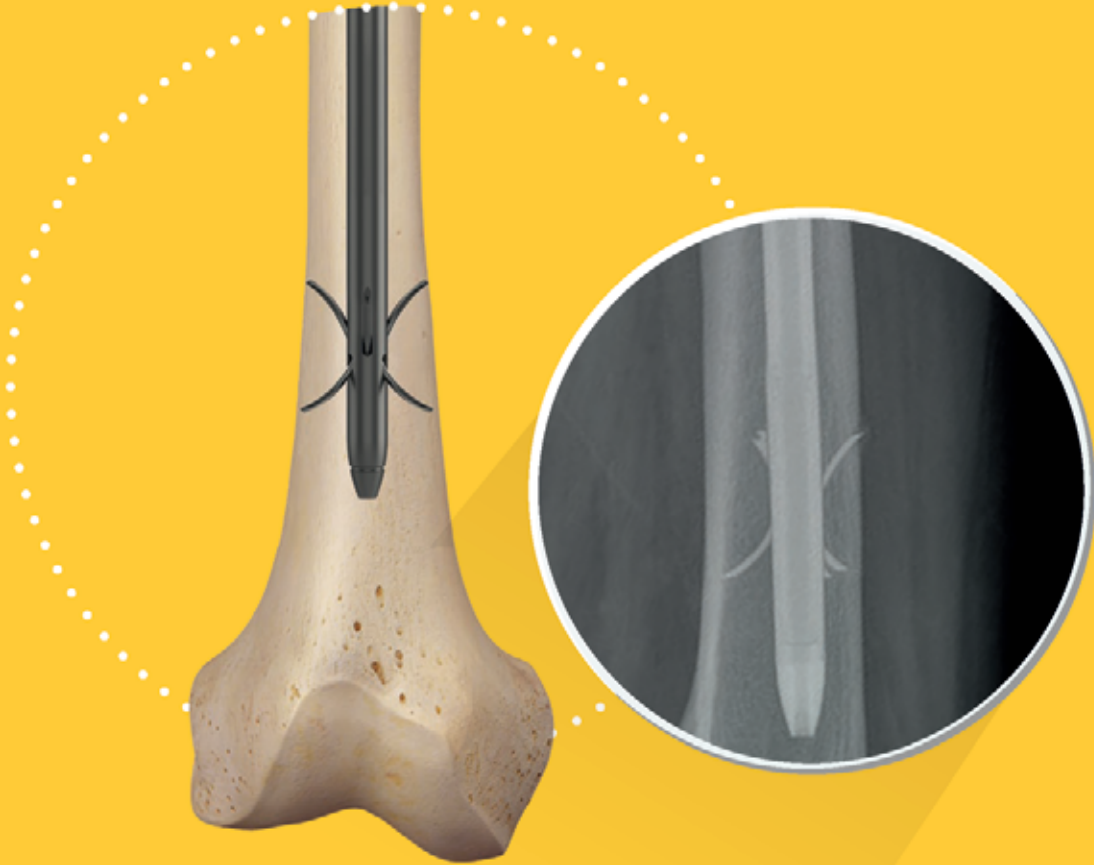

Less Radiation Exposure

Claws significantly reduce the radiation exposure of the team in the operating room by avoiding the need of targeting the distal hole, reaming and inserting a screw for distal locking.^{1,2}

Fewer Incisions

The nail is anchored by the Claws deployed from within the medullary canal. By avoiding extra incision, there will be fewer surgical scars, lower blood loss and shorter operative time while lowering the risk of infection.²

1. Çamurcu Y, Sofu H, İssin A, Koçkara N, Genç E, Çetinkaya M. Is talon tibial intramedullary nailing clinically superior compared to conventional locked nailing? *Eklemler Hastalıkları Cerrahisi*. 2017 Dec;28(3):152-7.

2. Zehir S, Şahin E, Zehir R. Comparison of clinical outcomes with three different intramedullary nailing devices in the treatment of unstable trochanteric fractures. *Ulus Travma Acil Cerrahi Derg* 2015, Vol. 21, No. 6.

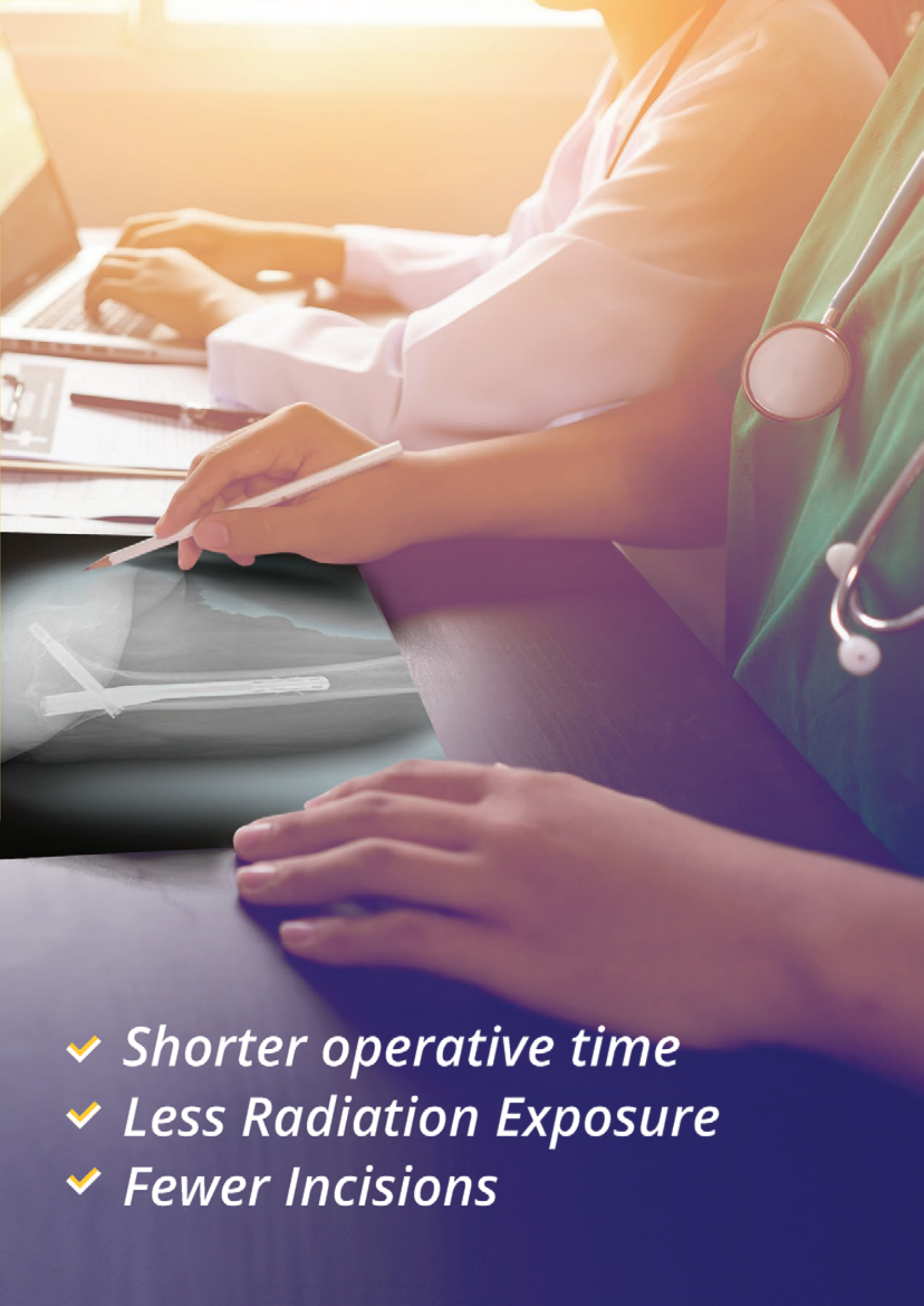

- ✓ *Shorter operative time*
- ✓ *Less Radiation Exposure*
- ✓ *Fewer Incisions*

Lag Screw Claw Technology

The internal fixation device should promote good rotational stability to allow for quick regeneration of the bone. Fracture gap or distraction are also important causes of nonunion.

To tackle these challenges, Dunitech's Lag Screw utilizes the Claw Technology. It presents three times more rotational stability and a two-fold increase in compression when compared to conventional systems.¹



3X More Rotational
Stability



2X More
Compression



Virtually no cut-out

Four retractable Claws anchor the lag screw into the cortical bone of the femoral head-neck junction for superior control.

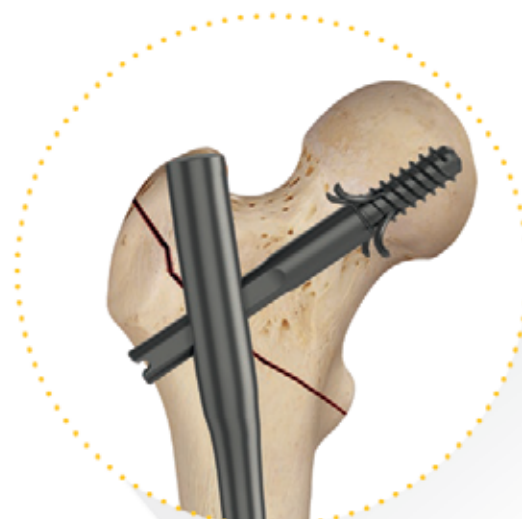
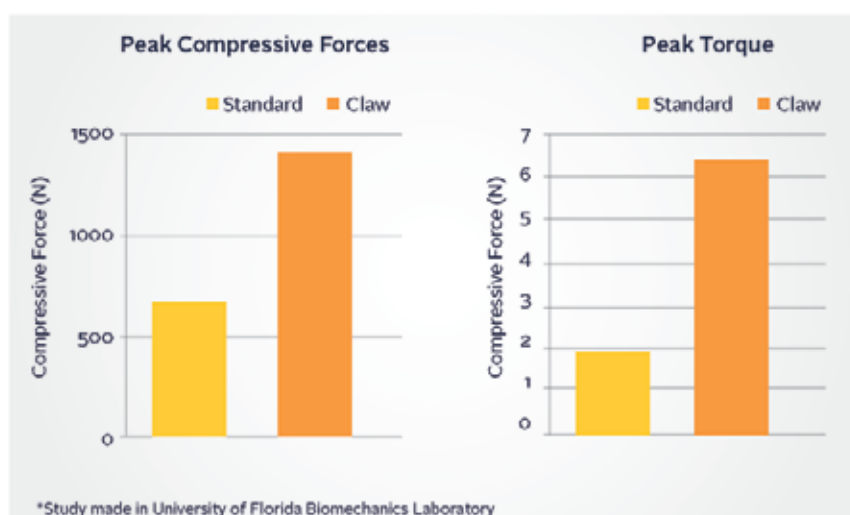

Rotational Stability

When deployed, the Claws' span is more than twice the diameter of the lag screw alone. The engagement of the Claws within the cortical bone at the junction between femoral head and neck leads to a three-time increase in the rotational resistance when compared to conventional screws.¹

Lag Screw Cut-out

Neon's lag screw is equipped with Claw technology. The Claws anchor the Lag Screw into the cortical bone granting a stronger fixation, preventing relative movement and reducing the risk of cut-out.²

Compression

Due to the increased purchase into the cortical bone, the lag screws present two times more compression forces than conventional screws.¹

1. Bramlet D, Wheeler D. Biomechanical evaluation of a new type of hip compression screw with retractable Claws. J Orthop Trauma 2003, 17:618-624.

2. Zehir S, Şahin E, Zehir R. Comparison of clinical outcomes with three different intramedullary nailing devices in the treatment of unstable trochanteric fractures. Ulus Travma Acil Cerrahi Derg 2015, Vol. 21, No. 6.

Neon Proximal Femoral Nail

Neon is a titanium nail designed for the treatment of proximal femoral fractures. By using the Claw technology in the distal end and lag screw, this nail allows surgeons to perform at their best in the operating room. Also, Neon has Short and Long versions with fully cannulated bodies compatible with guide-wire applications.

Indications

- ✓ Intertrochanteric fractures
- ✓ Stable and unstable pertrochanteric fractures
- ✓ High subtrochanteric fractures without shaft extension. Low subtrochanteric fractures (Neon Long Nails only)
- ✓ Osteoporotic fractures
- ✓ Pathologic / impending pathologic fractures
- ✓ Malunions / nonunions

Nail's key figures

- ✓ **Nail length**
Neon Short: 220 mm
Neon Long: 300 mm to 420 mm in 20 mm increment
- ✓ **Proximal Diameter**
15.5 mm
- ✓ **Distal Diameter**
11 mm
- ✓ **Distal Claw Maximum Span**
38 mm
- ✓ **Lag Screw Angle**
120°, 125° and 130°
- ✓ **End Cap Length**
0 mm to 10 mm in 5 mm increment
Internal thread to secure the cap to the driver

Lag Screw's key figures

- ✓ **Length**
70 mm to 120 mm in 5 mm increment
- ✓ **Thread Diameter**
11 mm
- ✓ **Compression Range**
15 mm
- ✓ **Lag Screw Claw Maximum Span**
28mm when fully deployed



Navy A/R Femoral Nail

Navy is a titanium nail designed for the treatment of femoral fractures. The Claw technology supports the surgeon to reach superior operative parameters.

Navy is compatible with Antegrade and Retrograde operating techniques, giving flexibility for the surgeon to choose the most appropriate approach for each fracture. The nail has a fully cannulated body, compatible with guide-wire applications and offers 10mm compression range.

Indications

- ✓ Femoral Shaft Fractures
- ✓ Ipsilateral hip / shaft fractures
- ✓ Ipsilateral femur / tibia fractures (floating knee)
- ✓ Supracondylar fractures including those with intraarticular extension
- ✓ Fractures proximal to a knee implant
- ✓ Osteoporotic fractures
- ✓ Pathologic / impending pathologic fractures
- ✓ Malunions / nonunions

Nail's key figures

- ✓ **Nail length**
280 mm to 460 mm in 20 mm increment
- ✓ **Proximal Diameter**
13 mm
- ✓ **Distal Diameter**
10 mm to 13 mm in 1 mm increment
- ✓ **Distal Claw Maximum Span**
38 mm
- ✓ **Compression Range**
10 mm
- ✓ **End Cap Length**
0 mm to 35 mm in 5 mm increment
Internal thread to secure the cap to the 5mm Hex Driver

Compression and Cortical Screws' key figures

- ✓ **Length**
30 mm to 120 mm in 5 mm increment
- ✓ **Diameter**
5 mm
Internal thread to secure the screw to the 5mm Hex Driver.
Compression Screw with threaded tip and 5 mm shaft to withstand compression load

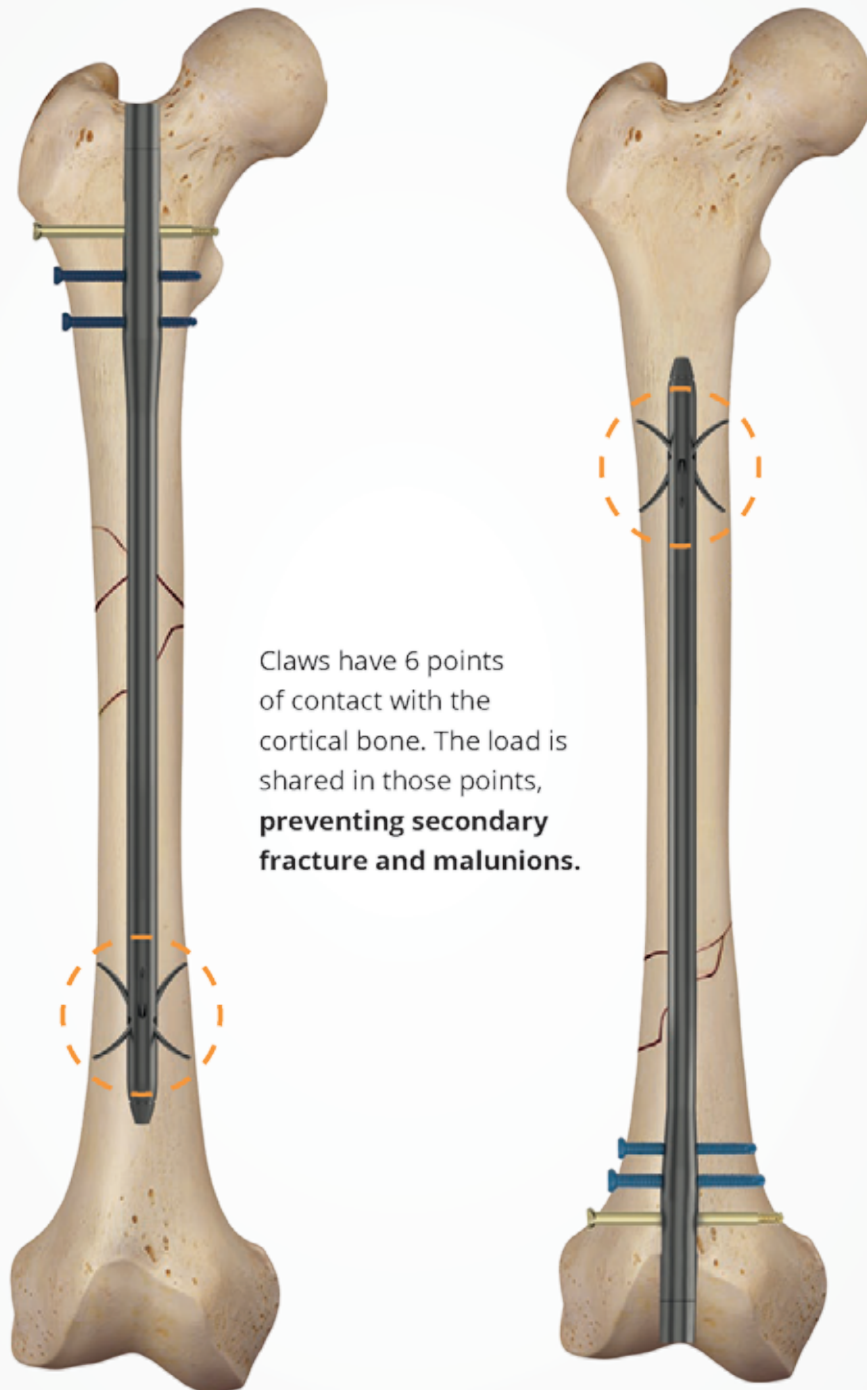

Nite Tibial Nail

Nite is a titanium nail designed for the treatment of tibial fractures. By using Claw technology for distal locking, Nite helps healthcare professionals to achieve superior operative and postoperative parameters.

Nite has a fully cannulated body compatible with guide-wire applications and offers 7 mm compression range, giving the surgeons more resources during the operation.

Indications

- ✓ Proximal extra-articular fracture
- ✓ Open and closed fractures of the tibial shaft
- ✓ Pathologic / impending pathologic fractures
- ✓ Malunions / nonunions

Nail's key figures

- ✓ **Nail length**
270 mm to 375 mm in 15 mm increment
- ✓ **Proximal Diameter**
11 mm
- ✓ **Distal Diameter**
9 mm to 11 mm in 1 mm increment
- ✓ **Distal Claw Maximum Span**
38 mm
- ✓ **Compression Range**
7 mm
- ✓ **End Cap Length**
0 mm to 20 mm in 5 mm increment
Internal thread to secure the cap to the 5mm Hex driver

Compression and Cortical Screws' key figures

- ✓ **Length**
30 mm to 120 mm in 5 mm increment
- ✓ **Diameter**
5 mm
Internal thread to secure the screw to the 5mm Hex driver.
Compression Screw with threaded tip and 5 mm shaft to withstand the compression load



Claws are deployed from within the nail, and do not protrude from the bone. This eliminates the **risk of vascular or nerve damage** as well as **discomfort** caused by conventional screws on the distal tibia.

Navy A/R - S (Universal) Femoral Nail

Navy-S is a titanium nail designed for the treatment of femoral fractures. Thanks to its novelty design, same nail can be used both of Antegrade and Retrograde operating techniques of both left and right femur.

With its wide range of indication length of femur, Navy-S gives flexibility for the surgeon to choose the most appropriate approach to reach fracture. The nail has a fully cannulated body, compatible with guide-wire applications and offers 10 mm compression range.

Indications

- ✓ Femoral Shaft Fractures
- ✓ Ipsilateral hip / shaft fractures
- ✓ Ipsilateral femur / tibia fractures (floating knee)
- ✓ Supracondylar fractures including those with intraarticular extension
- ✓ Fractures proximal to a knee implant
- ✓ Osteoporotic fractures
- ✓ Pathologic / impending pathologic fractures
- ✓ Malunions / nonunions

Nail's key figures

- ✓ **Nail length**
280 mm to 460 mm in 20 mm increment
- ✓ **Proximal Diameter**
13 mm
- ✓ **Distal Diameter**
10 mm to 13 mm in 1 mm increment
- ✓ **Compression Range**
10 mm
- ✓ **End Cap Length**
0 mm to 10 mm in 5 mm increments
Internal thread to secure the cap to the 5mm Hex Driver

Compression and Cortical Screws' key figures

- ✓ **Length**
30 mm to 120 mm in 5 mm increment
- ✓ **Diameter**
5 mm
Internal thread to secure the screw to the 5mm Hex Driver.
Compression Screw with threaded tip and 5 mm shaft to withstand compression load



Nite -S (Universal) Tibial Nail

Nite-S is a titanium nail designed for the treatment of tibial fractures. With its wide range of application areas, it can be used at shaft, proximal third and distal third fractures which are both stable and unstable.

Nite-S has fully cannulated body compatible with guide-wire application and offers 7 mm compression range, giving the surgeons more resources during the operation.

Indications

- ✓ Proximal extra-articular fracture
- ✓ Open and closed fractures of the tibial shaft
- ✓ Pathologic / impending pathologic fractures
- ✓ Malunions / nonunions

Nail's key figures

- ✓ **Nail length**
255 mm to 375 mm in 15 mm increment
- ✓ **Proximal Diameter**
11 mm (for 9 mm, 10 mm, 11 mm distal diameters)
12 mm (for 12 mm distal diameters)
- ✓ **Distal Diameter**
9 mm to 12 mm in 1 mm increment
- ✓ **Compression Range**
7 mm
- ✓ **End Cap Length**
0 mm to 10 mm in 5 mm increments
Internal thread to secure the cap to the 5mm Hex driver

Compression and Cortical Screws' key figures

- ✓ **Length**
30 mm to 120 mm in 5 mm increment
- ✓ **Diameter**
5 mm
Internal thread to secure the screw to the 5mm Hex driver.
Compression Screw with threaded tip and 5 mm shaft to withstand the compression load



Neon
Proximal Femoral Nail



Navy A/R
Femoral Nail



Navy A/R - S
Universal Femoral Nail



Nite
Tibial Nail



Nite - S
Universal Tibial Nail



Dunitech Instrument Sets



NEON TRAY 1

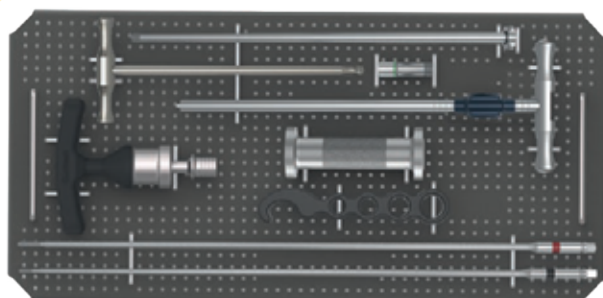

NEON TRAY 2

NEON INSTRUMENT SET

Neon instrument set delivers superior operative parameters in proximal femoral nail applications. Neon intuitive instruments help surgeons carry out efficient surgeries and reduce radiation exposure.

The high-quality materials used are carefully selected to ensure high performance and have a long life.

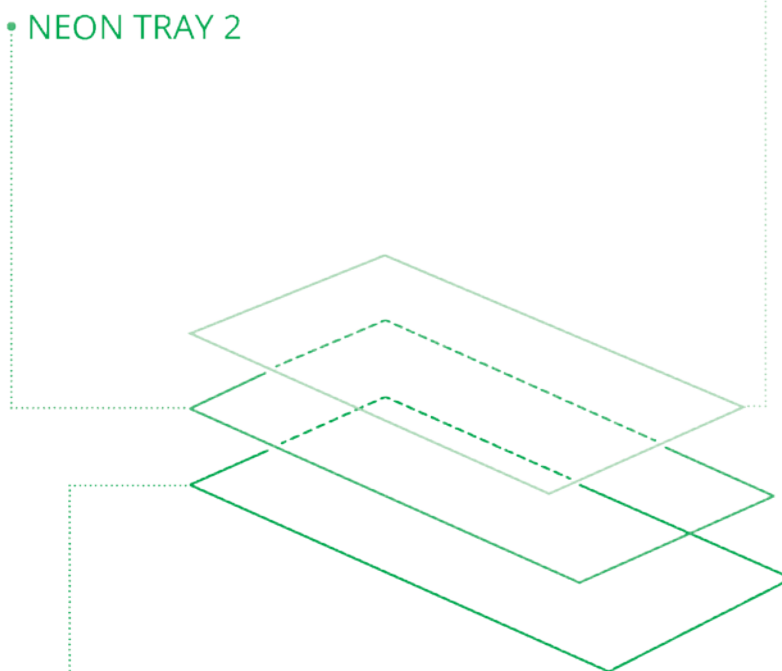

NEON TRAY 3

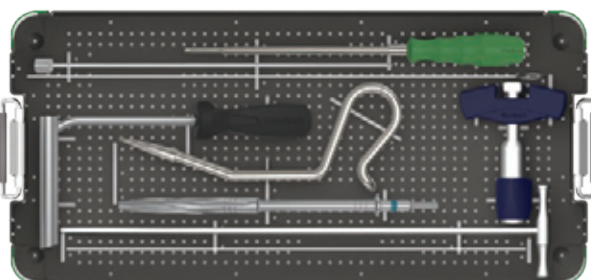

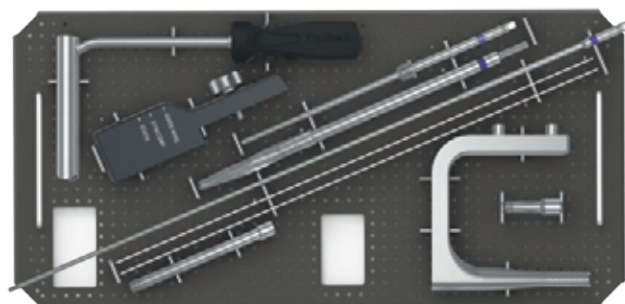

NAVY NITE TRAY 1

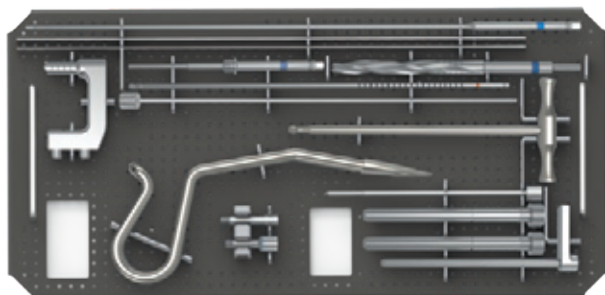

NAVY NITE TRAY 2

NAVY / NITE INSTRUMENT SET

Four nails with one set!

Navy A/R, Navy A/R-S Femoral Nail, Nite and Nite-S Tibial Nail can be implanted by using only one instrument set.

The instruments are color-coded to increase the efficiency of the surgery. The carefully designed system is lighter and smaller than having two separate sets, reducing inventory costs.

By using the same set for both surgeries, the instrument's idle time is shorter, increasing the utilization and revenue per set.

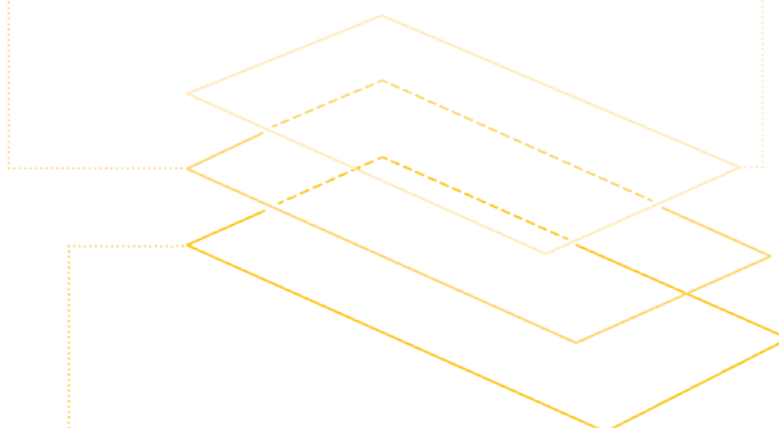

NAVY NITE TRAY 3

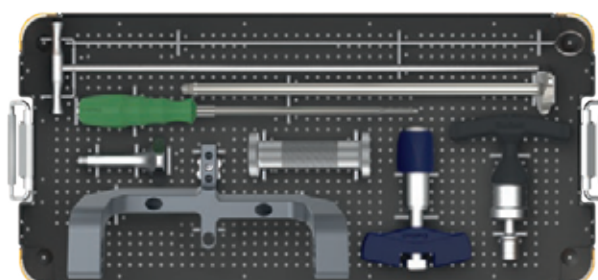

REVISION INSTRUMENT SET

One unified set for removal!

Dunitech's Revision Set is designed to improve the efficiency of the removal of all Dunitech nails. By carrying only the necessary instruments for the removal of the nails, the instrument case is simpler and lighter allowing the operating team to perform more efficiently. The very intuitive surgical technique and advantages of the Claw Technology such as quick and radiation-free retraction, lead to fast and safe implant removal.

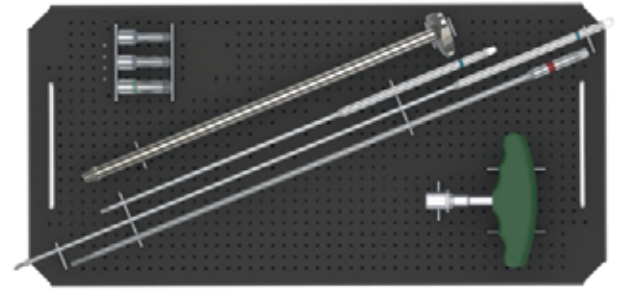

REVISION SET TRAY 1

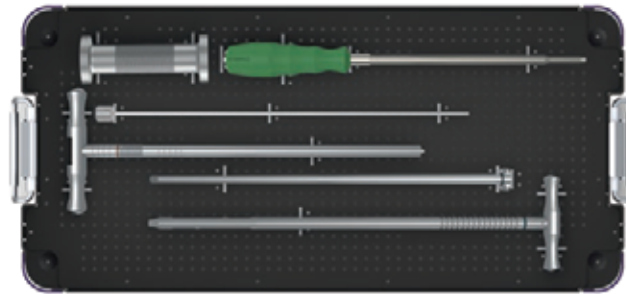

REVISION SET TRAY 2

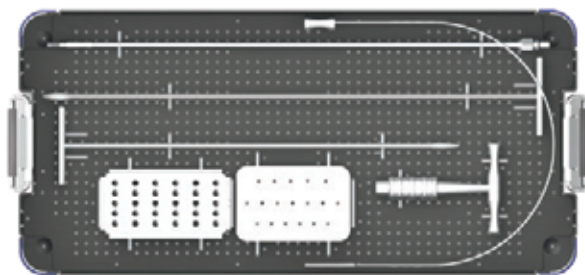
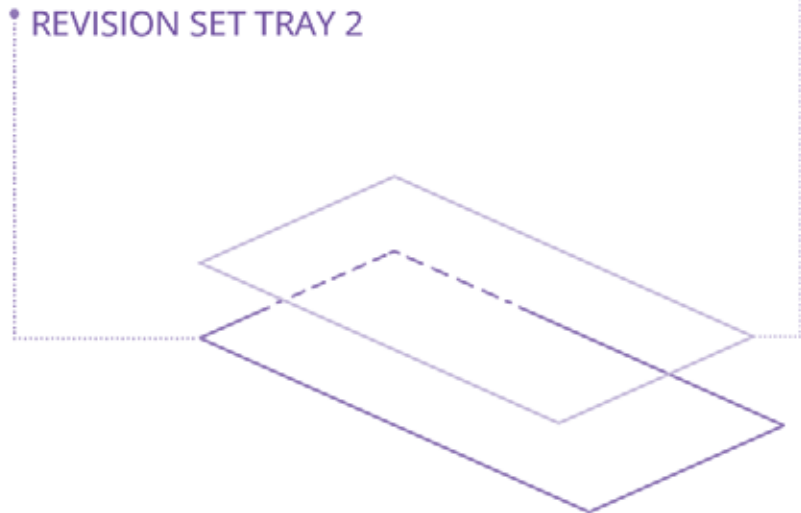

REAMER SET TRAY 1

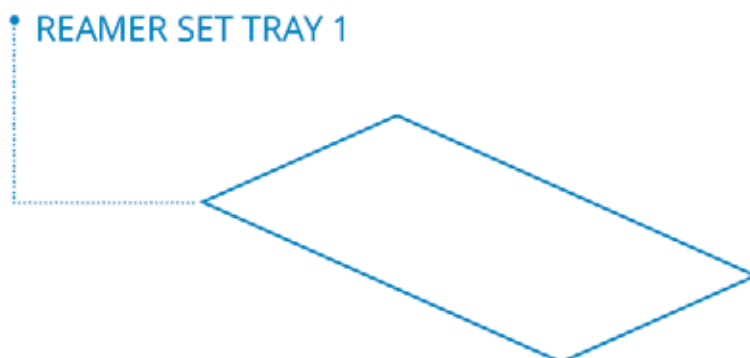

FLEXIBLE REAMER SET

Reaming is a critical moment of the surgery. Dunitech's Flexible Reamer Set supports the surgeon to perform a fast and efficient reaming and prepare the canal to accommodate the intramedullary nail safely. The third generation flexible reamer shaft and a full range of modular reamers covers every surgical need.

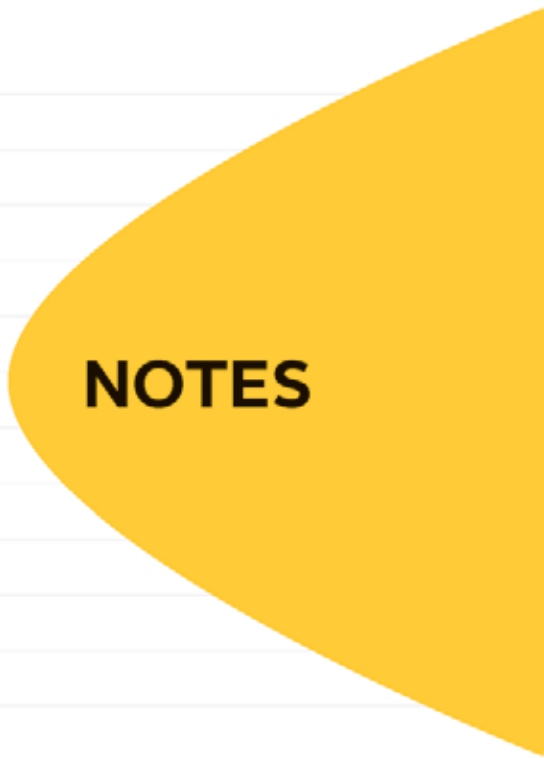

NOTES

Lined writing area for notes.

Product availability is subject to the regulatory and/or medical practices in individual markets. Some or all products described in those documents may not be available in your region. Please contact your Dunitech representative for information regarding product availability in your area.

OLIGA MAKINA ELEKTRONIK SANAYI LTD. STI.

🏠 İvedik OSB Mh. 1453 Cd. 1472 Sk. No: 5/D 06378 Yenimahalle, Ankara / TURKEY
📍 Çukurambar Mh. Öğretmenler Cd. 1472 Sk. No: 4/1 06510 Çankaya, Ankara / TURKEY
☎ +90 312 220 1577 info@oliga.com.tr / www.oliga.com.tr
Info@duni-tech.com / www.duni-tech.com



