

Nite Tibial Nail

Surgical Technique

*Special thanks to
Contributing Surgeons,*

Yalkın ÇAMURCU, MD,

Department of Orthopedics and Traumatology
Medical Faculty of Erzincan University
Erzincan, Turkey

Mehmet Cenk Cankuş, MD, FEBOT

Department of Orthopedics and Traumatology
Medical Faculty of Sanko University
Gaziantep, Turkey

Get Better

Expertise and enthusiasm can be perfectly combined into a top-notch medical engineering company!

We contribute to the development of health services by providing superior technology products at competitive costs.

We envision a socially conscious business environment serving the health industry and patients get better.

Dunitech branded products are designed and engineered to keep our promise;

Easier Operation
Better Fixation

TABLE OF CONTENTS

Nite Tibial Nail

▶ INTRODUCTION

Claw Technology.....	8
Get Better Stability.....	9
Claws in Action.....	10
Nite Tibial Nail Specification.....	11
Nite Tibial Nail Indications	12

▶ SURGICAL TECHNIQUE

Patient Positioning and Fracture Reduction.....	16
Incision and Entry Point.....	16
Accessing the Canal.....	18
Proximal Reaming.....	19
Determining the Nail Length.....	21
Distal Reaming.....	22
Attaching the Nail.....	24
Checking Alignment.....	25
Inserting the Nail.....	26
Deploying Claws.....	28
Proximal Locking – Drilling for Locking Screw.....	30
Proximal Locking – Inserting the Screw.....	31
Proximal Locking – Compression.....	32
Inserting End Cap.....	34

▶ NAIL REMOVAL

Removing Nail End Cap.....	39
Removing the Cortical Screws.....	39
Retracting Nail Claws.....	40
Removing the Nail.....	41
Correct Use of the Flexible Shaft.....	42
Catalogue Information.....	44

Claw Technology

Dunitech leads innovational systems, and aims to supply options for the surgeons to excel at their expertise. Claws are a novelty solution on distal locking systems designed to support the orthopedic trauma community.

Claws are titanium pins that act as anchors to provide a stable fixation, as well as other superior operative parameters.

- ✓ *Claws are made from titanium, and mechanically deploy from within the nail.*
- ✓ *Claws penetrate through the cancellous bone, and anchor in the cortical bone.*

We focus on operative parameters that are vital for the success of the fracture treatment.

Dunitech's innovative devices allow healthcare professionals to reduce surgical time as well as the risk of pre- and postoperative complications.

By eliminating the distal incisions, the Claws significantly reduce the radiation exposure and blood loss.

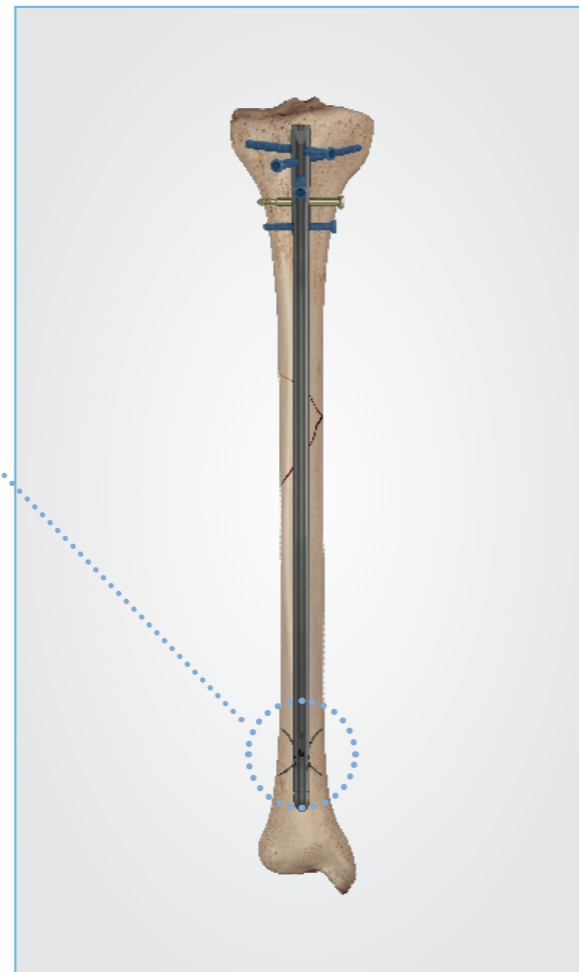

- ✓ *Increased stability*
- ✓ *Shorter operative time*
- ✓ *Lower radiation exposure*
- ✓ *Fewer incisions*
- ✓ *Easy revision*
- ✓ *No free-hand locking*
- ✓ *Less bone removal*

Get Better Stability!

Six retractable Claws are designed to penetrate the cortex, and provide exceptional axial and rotational stability.

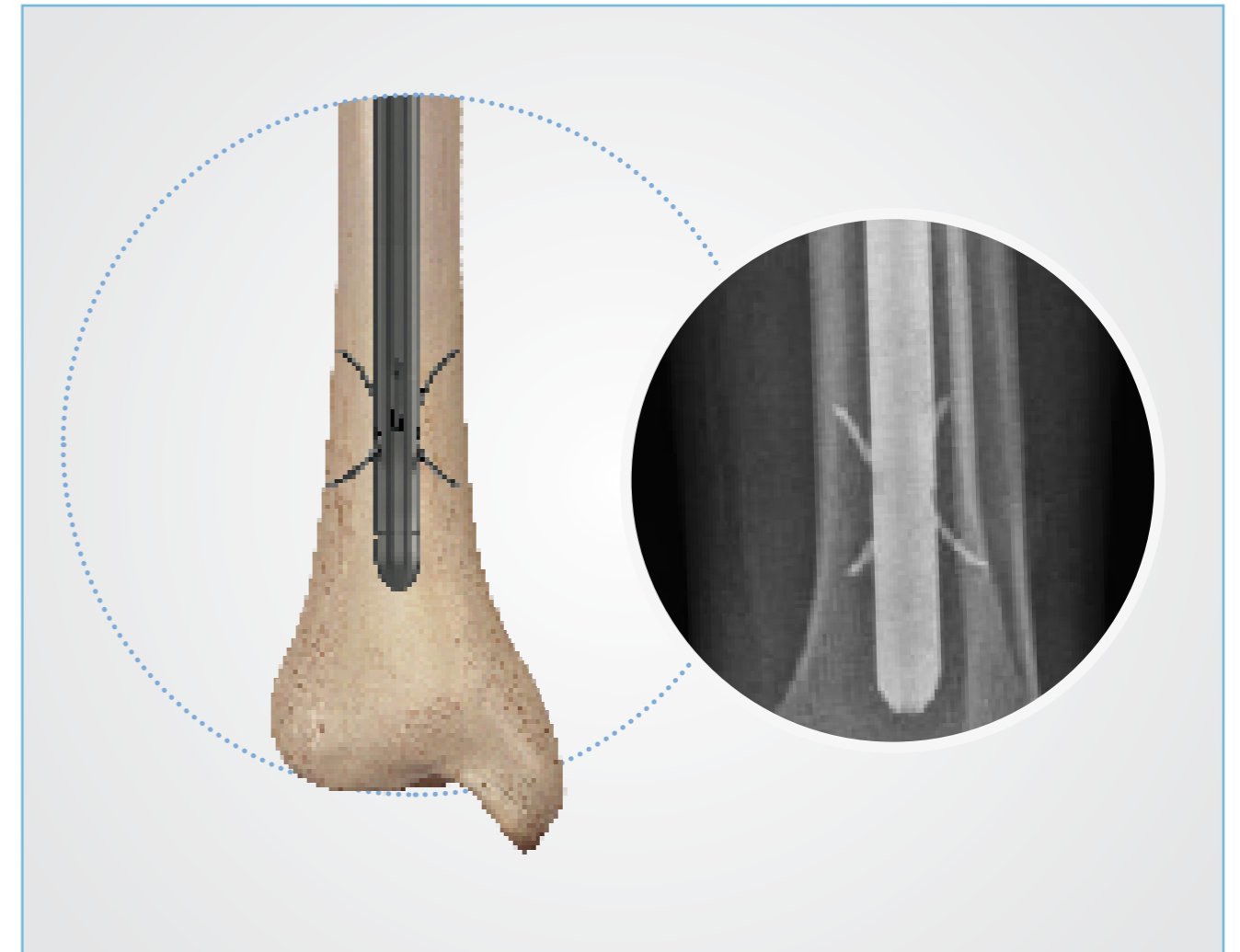

Less Radiation Exposure

Claws significantly reduce the radiation exposure of the team in the operating room by avoiding the need of targeting the distal hole, reaming and inserting a screw for distal locking.^{1,2}

Fewer Incisions

The nail is anchored by the Claws deployed from within the medullary canal. By avoiding extra incision, there will be fewer surgical scars, lower blood loss and shorter operative time while lowering the risk of infection.²

1. Çamurcu Y, Sofu H, İssin A, Koçkara N, Genç E, Çetinkaya M. Is talon tibial intramedullary nailing clinically superior compared to conventional locked nailing? *Eklemler Hastalıkları Cerrahisi*. 2017 Dec;28(3):152-7.

2. Zehir S, Şahin E, Zehir R. Comparison of clinical outcomes with three different intramedullary nailing devices in the treatment of unstable trochanteric fractures. *Ulus Travma Acil Cerrahi Derg* 2015, Vol. 21, No. 6.

Claws in Action

Claws are **reliably retractable!**

All Claws were **successfully retracted** after every test.

Conventional systems are subjected to screw breakage, screw head wear and drill bit breakage that may prevent the nail to be removed. Dunitech Claws are deployed within the nails from precise holes in a tight fit, preventing empty spaces for bone ingrowth.

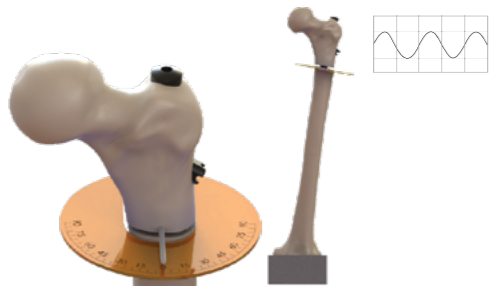

Rotational Stability

In unstable subtrochanteric fractures Claws provide superior rotational stability. After 10,000 cycles, the nail settled in and remained fixed until 100,000 cycles.

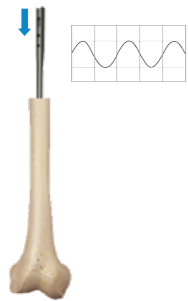
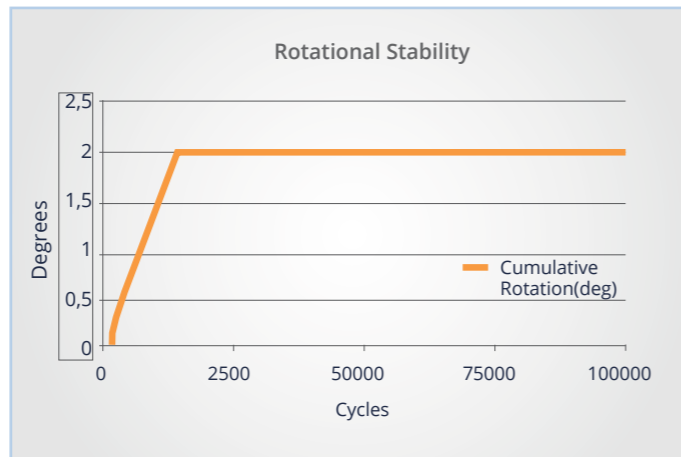

Claw's Axial Fatigue Strength

The average displacement observed at 1 million cycles was 0.74 mm.

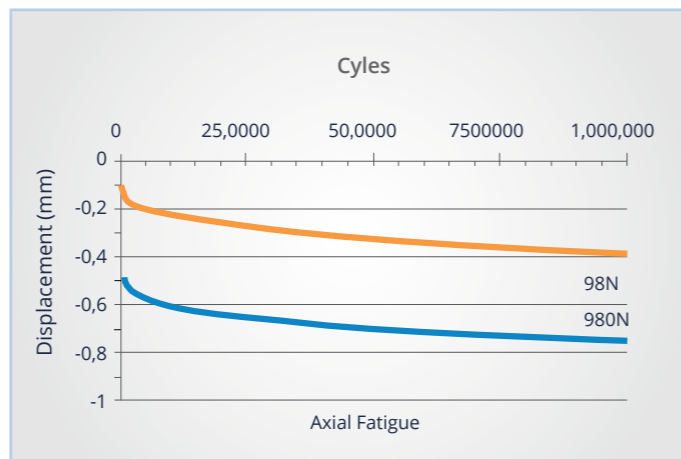

Claw's Axial Static Strength

Claws resist to a higher force for a given displacement, compared to conventional stainless steel screws.

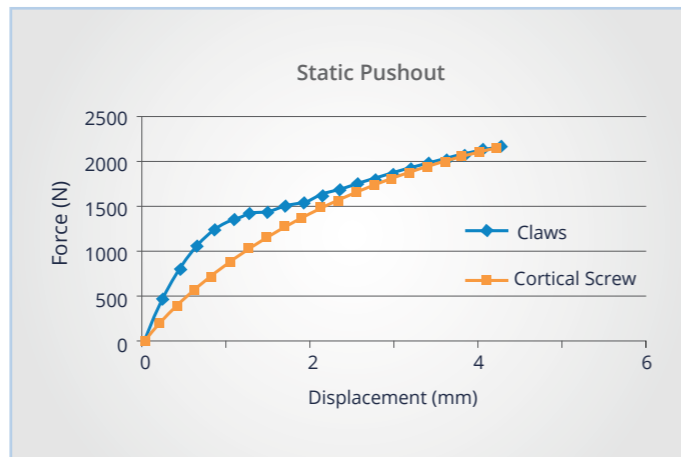

Nite Tibial Nail Specifications

NITE KEY FIGURES

- Nail Length: 270 mm to 375 mm in 15 mm increment
- Proximal Diameter: 11 mm
- Distal Diameter: 9 mm to 11 mm in 1 mm increment
- Distal Claw Maximum Span: 38 mm
- Compression Range: 7 mm
- End Cap Length: 0 mm to 10 mm in 5 mm increments Internal thread to secure the cap to the 5 mm Hex driver

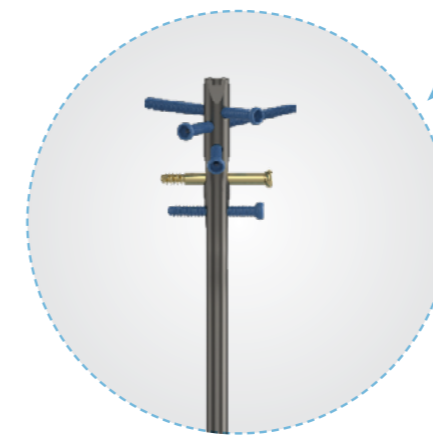
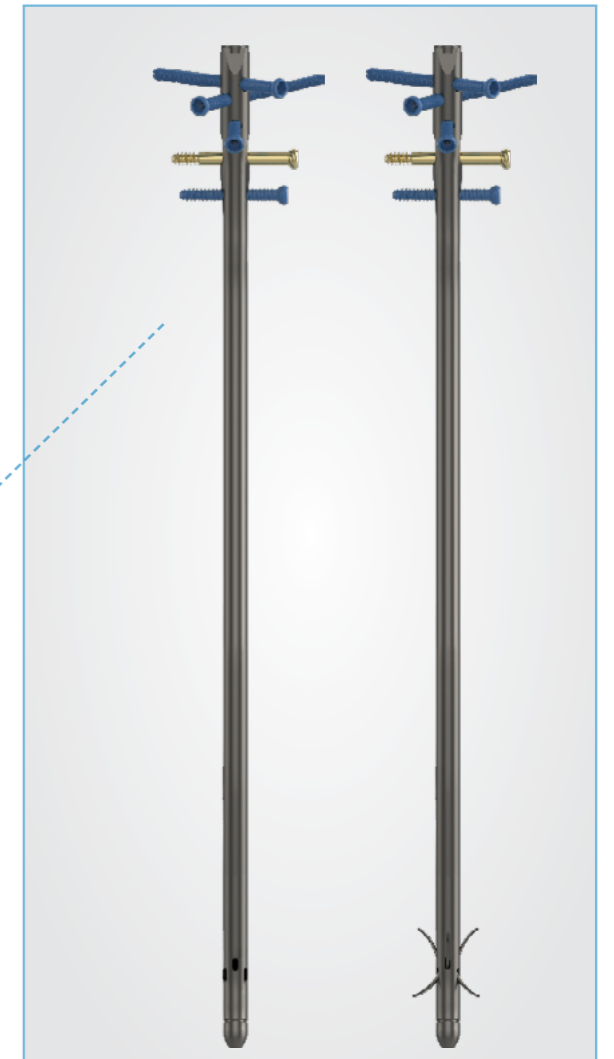

COMPRESSION AND CORTICAL SCREWS' KEY FIGURES

- Length: 30 mm to 120 mm in 5 mm increment
- Diameter: 5 mm

Internal thread to secure the screw to the 5 mm Hex Driver.

Compression Screw with threaded tip and 5 mm shaft to withstand compression load

Nite Tibial Nail Indications

INDICATIONS

- Proximal extra-articular fracture
- Open and closed fractures of the tibial shaft
- Pathologic / impending pathologic fractures
- Malunions / nonunions

CONTRAINDICATIONS

- In a leg with a total knee implant.
- Fractures of the distal third.

The following conditions may present an increased risk of implant failure. This list is not meant to be comprehensive. Physicians should use their clinical judgement when determining the appropriate implant and approach for a given patient.

- Infection
- Incomplete fusion of the epiphysis
- Cognitive and/or physical impairment that would lead to unacceptable risk of fixation failure
- Metal sensitivity or allergic reaction to foreign bodies
- Loss of bone stock or insufficient bone quality to support the device
- Obliterated or narrow medullary canal
- Obese patients
- In the same region as a pre-implanted screw plate
- In comminuted and/or intraarticular fractures
- In open fractures with inadequate soft tissue cover and/or with associated arterial injury

PRECAUTIONS

Nite Tibial Nail and accessories were not evaluated for safety and compatibility in the magnetic resonance (MR) environment and no tests for heating or migration were conducted for those products in MR environment.



1. Patient Positioning and Fracture Reduction

- Place the patient in the supine position according to surgeon preference on a fracture or other radiolucent table with the knee hyperflexed (>90°). A triangle may be used to stabilize the limb during the surgery (Fig-1). Alternatively, the patient can be placed supine with the limb hung over the edge of the table or in a traction table with a bump beneath the distal femur to flex the knee.

Note:

- ✓ The bump or triangle should be placed beneath the distal femur to reduce the risk of vascular compression and/or displacing the proximal fragments of the tibia.

- Position the image intensifier as to ensure that AP and lateral views of the entire tibia can be easily obtained.
- Reduce the fracture as anatomically as possible through closed reduction before prepping and draping the patient with the help of image intensifier. Manual traction or a distraction device may be used to assist in fracture reduction.

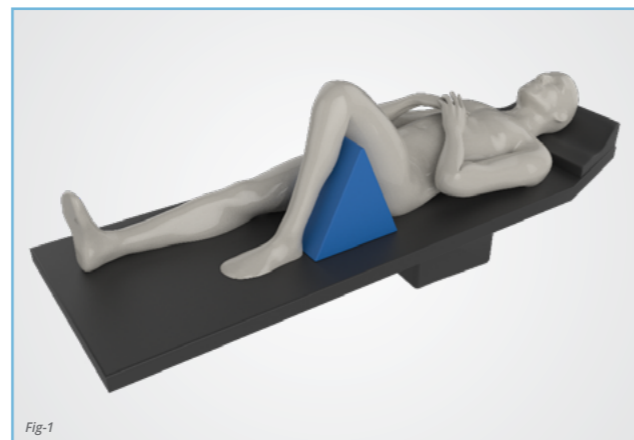

2. Incision and Entry Point

- The entry point is along the ventral edge of the tibial plateau and in line with the axis of the intramedullary canal and with the lateral tubercle of the intercondylar eminence (Fig-2 and Fig-3).
- Confirm the correct entry point with the image intensifier in the AP and lateral views.
- To expose the entry point, make an incision in line with the intramedullary canal. The incision starts from the patella along the patellar ligament until the tibial tuberosity.

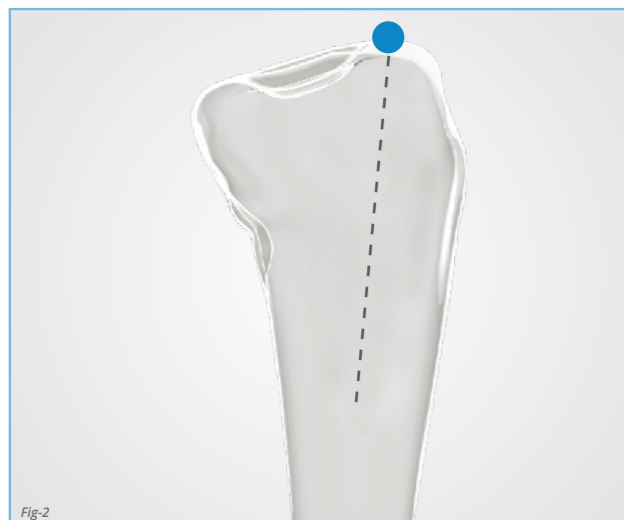

INSTRUMENTS FOR REMOVING THE NAIL

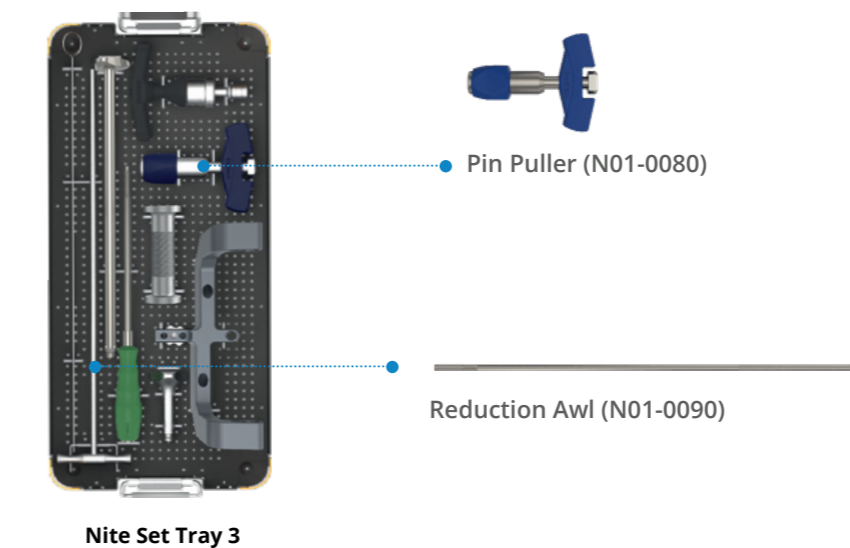
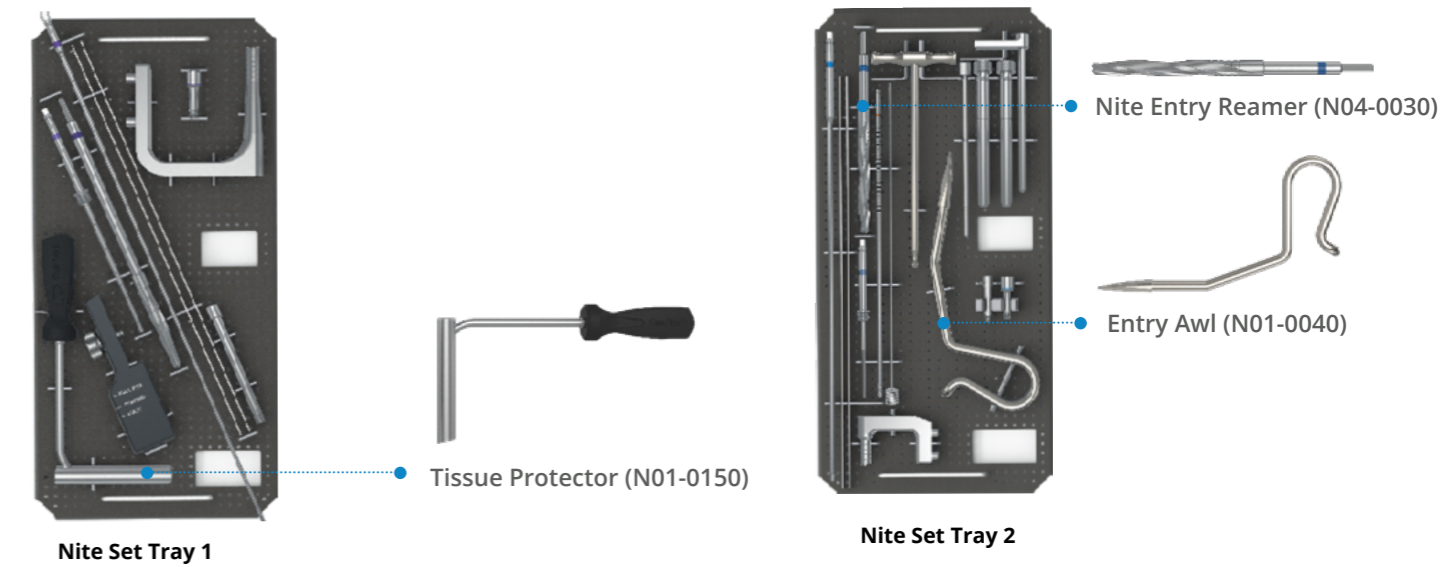

Trocar Tip Guide Wire 3 mm x 600 mm (N01-0250)

Ball Tip Guide Wire 2 mm x 900 mm (N01-0290), for Nite 9 and 10 mm

2 mm Guide Wire Sheath (N01-0300), for Nite 9 and 10 mm

Ball Tip Guide Wire 3 mm x 900 mm (N01-0270), for Nite 11 mm

3 mm Guide Wire Sheath (N01-0280), for Nite 11 mm

3. Accessing the Canal

Option 1: Trocar Tip Guide Wire

INSTRUMENTS:

- ✓ Trocar Tip Guide Wire 3 mm x 600 mm (N01-0250)

- Advance the 3 mm Trocar Tip Guide Wire through the entry point and into the proximal tibia with the help of a powered driver to a depth of 8 mm to 10 mm.
- The wire should be centered in the canal on the AP view (Fig-4). On the lateral view, the angle of the wire with respect to the intramedullary canal should match the 8° proximal bend of the nail (Fig-5).
- Withdraw and reposition the wire as necessary.

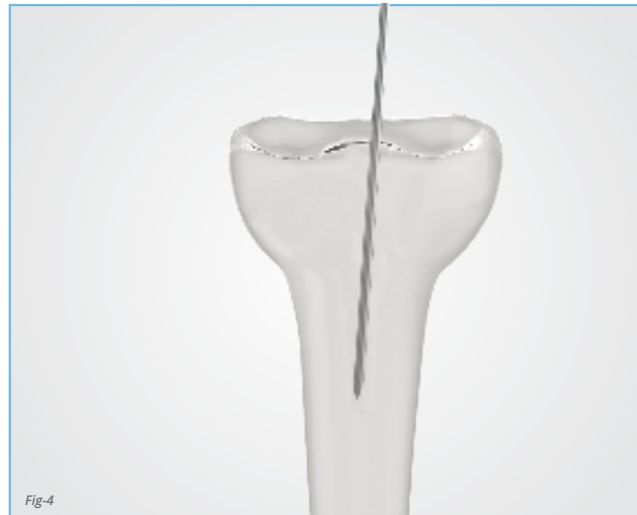

Option 2: Entry Awl and Trocar Tip Guide Wire

INSTRUMENTS:

- ✓ Entry Awl (N01-0040)
- ✓ Trocar Tip Guide Wire 3 mm x 600 mm (N01-0250)

- Insert the Entry Awl through the incision and down to the bone (Fig-6). Rotate the Entry Awl back and forth to penetrate the proximal tibia. Care must be taken not to displace the fracture.
- Pass the 3 mm Trocar Tip Guide Wire through the Entry Awl and down to the bone.
- Withdraw and reposition the wire as necessary.



4. Proximal Reaming

INSTRUMENTS:

- ✓ Tissue Protector (N01-0150)
- ✓ Nite Entry Reamer (N04-0030)
- ✓ Ball Tip Guide Wire 2 mm x 900 mm (N01-0290), for Nite 9 and 10 mm
- ✓ 2 mm Guide Wire Sheath (N01-0300), for Nite 9 and 10 mm
- ✓ Ball Tip Guide Wire 3 mm x 900 mm (N01-0270), for Nite 11 mm
- ✓ 3 mm Guide Wire Sheath (N01-0280), for Nite 11 mm
- ✓ Pin Puller (N01-0080)
- ✓ Reduction Awl (N01-0090)

- Insert the Tissue Protector through the incision and down to the bone. Secure the Nite Entry Reamer to a powered driver. Pass over the wire and through the Tissue Protector. Ream the proximal tibia to the desired depth with the help of the image intensifier (Fig-7). Care should be taken not to ream the posterior cortex.
- The grooves on the cutting blade of the Nite Entry Reamer are depth templates. The first groove represents the head of the nail. The superior grooves are spaced in 5 mm increments, representing the position of the different end caps (Fig-8).

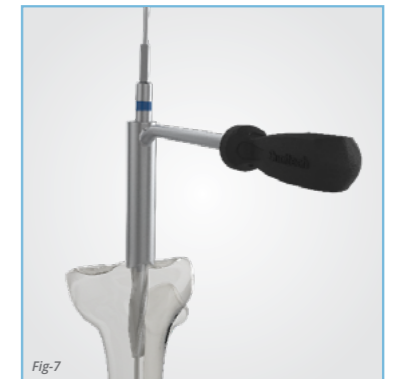

Note:

- ✓ If compression or dynamization is necessary, the nail head placement will be different than indicated during proximal reaming (e.g. if 5 mm compression is done, the nail head will be 5 mm more proximal than indicated by the Nite Entry Reamer). This should be considered while reaming.

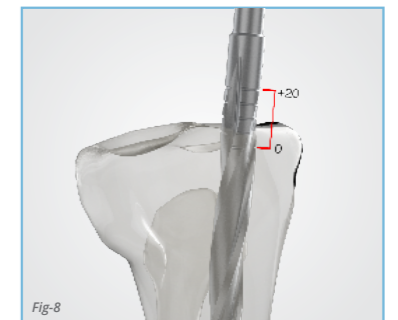

- Exchange the 3 mm Trocar Tip Guide Wire to the Ball Tip Guide Wire and 3 mm Guide Wire Sheath. Loosen up the Pin Puller's lock and pass the Guide Wire through it. Lock the wire by rotating the Pin Puller's drum and move it to the desired depth (Fig-9). Ensure that the guide wire is in correct position with the help of image intensifier. Withdraw and reposition the wire as necessary.
- Confirm that the fracture is well reduced. If necessary use the Reduction Awl to assist with the fracture reduction or guide wire change.



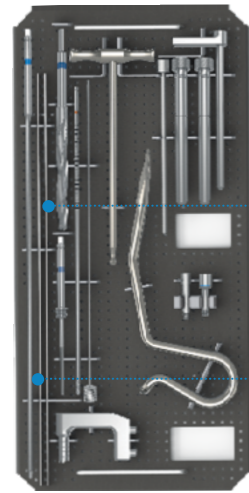

Nite Set Tray 2



Nite Radiographic Claw Template 9-10 mm (N04-0080)



Nite Radiographic Claw Template-11 mm (N04-0090)

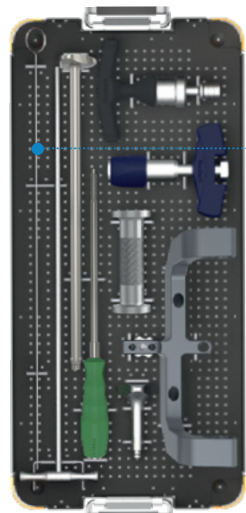

Nite Set Tray 3



Guide Wire Pusher (N01-0060)



Modular Flexible Reamer Shaft (N01-0240)



Modular Reamer Cutter Head (N01-0XX0)

5. Determining the Nail Length

INSTRUMENTS:

✓ Nite Radiographic Claw Template – 9 mm and 10 mm (N04-0080), for Nite 9 mm and 10 mm

✓ Nite Radiographic Claw Template – 11 mm (N04-0090), for Nite 11 mm

- Confirm that the fracture is well reduced and place the appropriate Nite Radiographic Claw Template over the affected leg. Use N04-0080 for nails with distal diameter of 9 mm or 10 mm and N04-0090 for nails with distal diameters of 11 mm. The template shows approximately the full opening of the Claws.
- Position the image intensifier in AP view over the distal tibia to assist with the template placement. The four claws of the template should be above the metaphyseal flare and well into the cortical bone (Fig-10b). This will help select the longest recommended nail and ensure that the Claws, when deployed, will anchor the nail correctly.
- Care should be taken to avoid placing the Claws close to the fractured site. The Claws must be deployed in unaffected bone to allow for strong nail fixation.
- Move the image intensifier to the proximal tibia. Choose the length that corresponds to the nail depth defined during the proximal reaming or to the desired nail head position. If compression will be necessary, the head of the nail will move to a more proximal position (Fig-10).

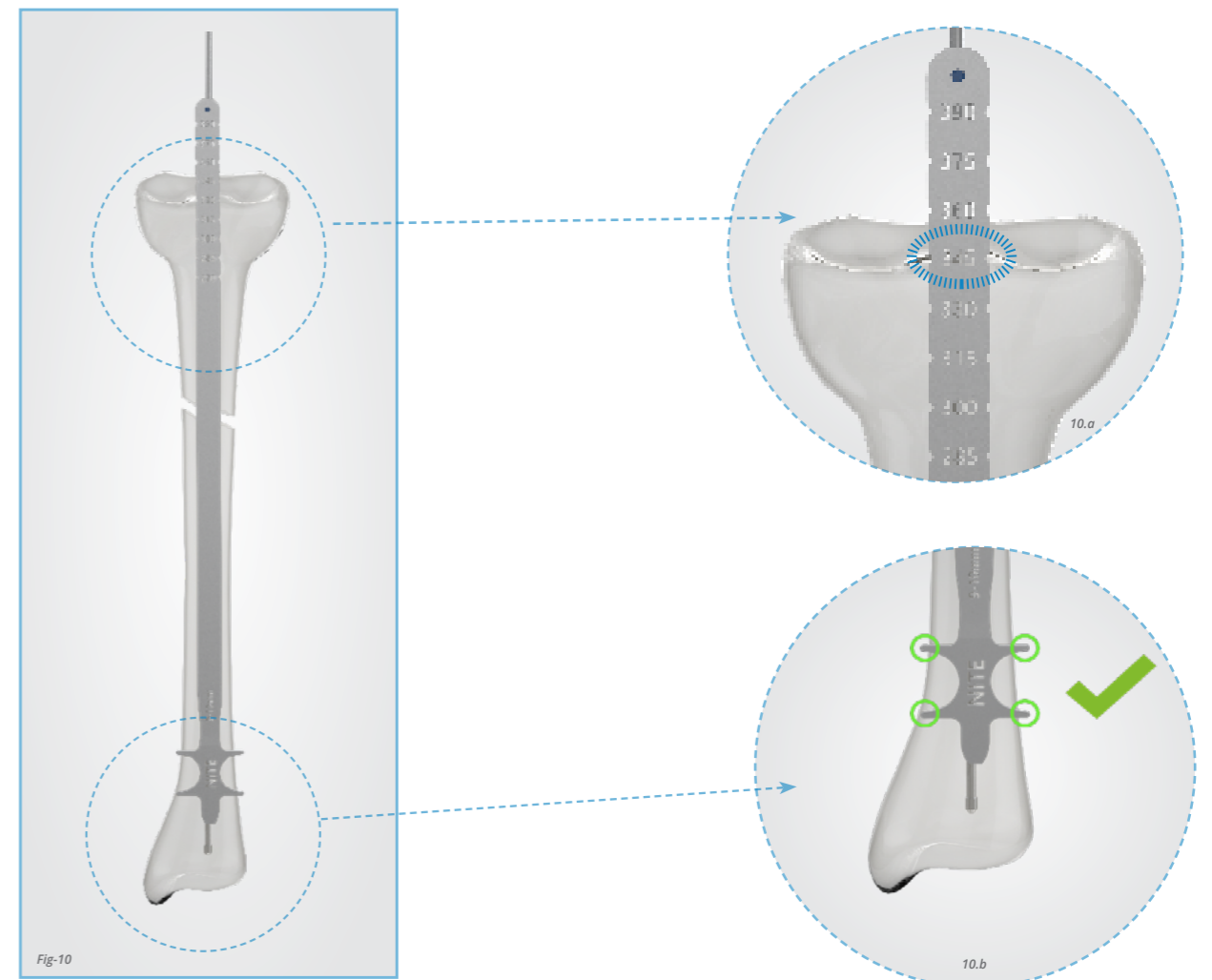

6. Distal Reaming

INSTRUMENTS:

- ✓ *Dunitech Intramedullary Reamer Set (INST-01-002)*
- ✓ *Guide Wire Pusher (N01-0060)*

- Confirm that the fracture is well reduced. Starting from 8.5 mm Reamer Cutter Head, ream until the desired depth with a steady pressure (Fig-11). By each pass, increase the diameter of the Reamer Cutter Head in 0.5 mm increments. Use the Guide Wire Pusher to keep the guide wire in place. If the sheath comes out with the reamer, insert it back before starting the next pass.
- The canal should be reamed to at least 1 mm above the desired nail diameter. Ream to at least 10 mm (the nail with smallest diameter has 9 mm of distal diameter). If there's no resistance to reaming to 10 mm, increase the reaming diameter to fit the next size of nail to a maximum of 12 mm.
- To prevent accumulation of debris in the medullary canal, retract the reamer when necessary.
- After distal reaming, remove the sheath (Fig-12). The Sheath won't pass through the nail. If needed, use the Guide Wire Pusher to keep the Ball Tip Guide Wire in place.



INSTRUMENTS FOR TARGET GUIDE ASSEMBLY AND NAIL INSERTION

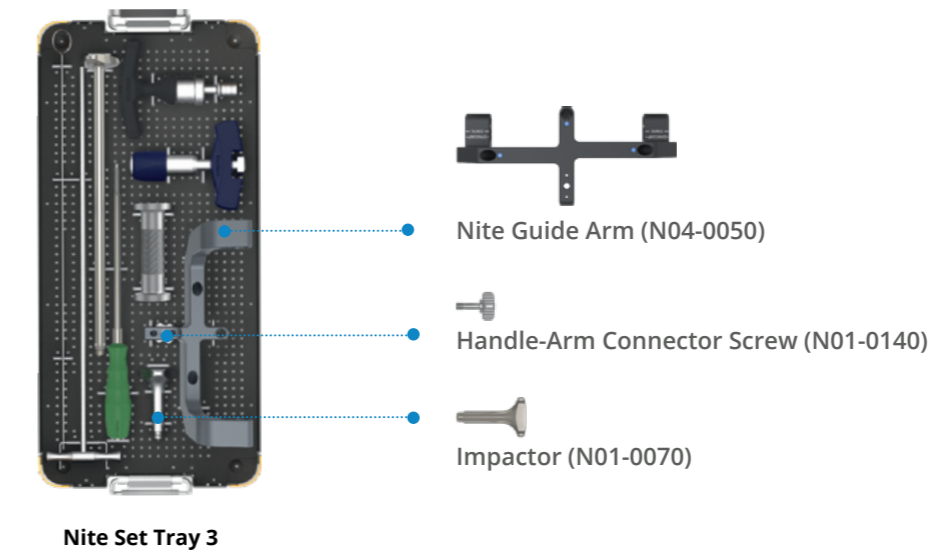
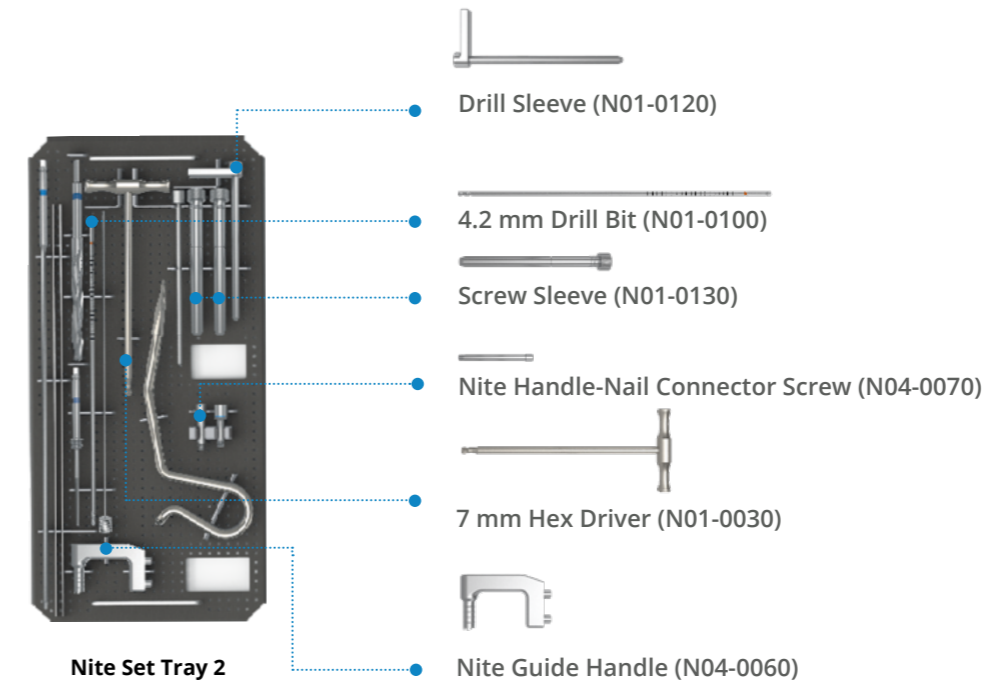

7. Attaching the Nail

INSTRUMENTS:

- ✓ Nite Handle-Nail Connector Screw (N04-0070)
- ✓ 7 mm Hex Driver (N01-0030)
- ✓ Nite Guide Handle (N04-0060)

- Mate the desired nail to the Nite Guide Handle. Ensure that the reference line on the nail is aligned with the corresponding line on the Guide Handle. Pass the Handle-Nail Connector Screw and use the 7 mm Hex Driver to secure it to the nail (Fig-13). Ensure that the connection is tight before proceeding.

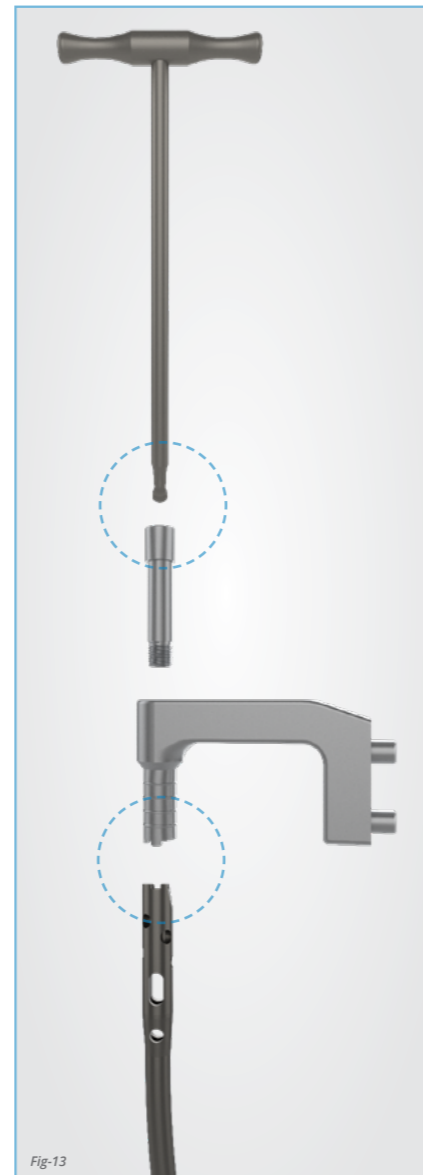

8. Checking Alignment

INSTRUMENTS:

- ✓ Nite Guide Arm (N04-0050)
- ✓ Handle-Arm Connector Screw (N01-0140)
- ✓ Screw Sleeve (N01-0130)
- ✓ Drill Sleeve (N01-0120)
- ✓ 4.2 mm Drill Bit (N01-0100)

- Before inserting the nail check the nail's holes are correctly aligned to the holes of the Guide Arm.
- Mate the Nite Guide Arm with the Nite Guide Handle and secure them with the Handle-Arm Connector Screw (Fig-14). Insert the Drill Sleeve into the Screw Sleeve and insert this assembly into the Dyn/Comp hole of the Guide Arm. Insert the 4.2 mm Drill bit through the Drill Sleeve and advance until it passes through the corresponding nail hole (Fig-15). Repeat the process in the other holes.
- Prior to inserting the nail, remove the Nite Guide Arm.



9. Inserting the Nail

INSTRUMENTS:

- ✓ *Impactor (N01-0070) - Optional*

Note:

- ✓ If the Guide Wire Sheath has not been removed, it has to be removed in before the insertion of the nail (Fig-12). If a traditional ball tip guide wire was used, it must be exchanged for a smooth guide wire. Its tip won't pass through the nail.

- Pass the nail over the guide wire, through the incision and into the bone. With steady pressure and gentle rotation movements, advance the nail (Fig-16). Monitor closely with the help of image intensifier the passage of the nail across the fracture site.
- If needed, the Impactor can be assembled in the Guide Arm for light hammer blows. If considerable resistance is encountered, do not use strong hammer strikes. It may cause loss of reduction or perioperative fracture. Instead, remove the nail, replace the sheath and further enlarge the medullary canal.
- The rings in the handle are spaced 5 mm from each other, they indicate the depth of the nail's head.

Note

- ✓ Do not strike the Guide Handle with a slap hammer or any other mallet.

- Once the nail is in its final position, remove the guide wire (Fig-17).



INSTRUMENTS FOR NAIL CLAWS DEPLOYMENT

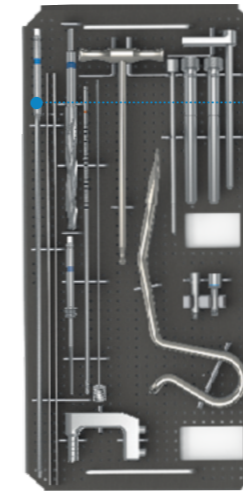

Nite Set Tray 2

Nite Claw Deployment Driver (N04-0020)

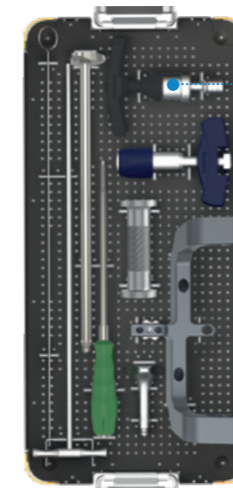

Nite Set Tray 3



Torque Limiting Handle (N01-0170)

10. Deploying Claws

INSTRUMENTS:

- ✓ *Nite Claw Deployment Driver (N04-0020)*
- ✓ *Torque Limiting Handle (N01-0170)*
- Attach the Nite Claw Deployment Driver to the Torque Limiting Handle. Insert the driver down the nail until it engages the Claw mechanism.
- Rotate the handle clockwise to deploy the Claws. A steady low torque should be felt before the cortical bone is reached. An increase in torque will indicate that the Claws started penetrating the cortex. During this stage, monitor under image intensifier positioned for a lateral view to prevent excessive cortical penetration.
- Full deployment of the Claw system is reached after 18 full turns of the handle. The amount of turns needed will depend on patient anatomy and nail placement. Stop deploying when full cortical anchoring is reached or when the Torque Limiting Handle trips to prevent excessive perforation through the cortical bone and into the soft tissue (Fig-18b).

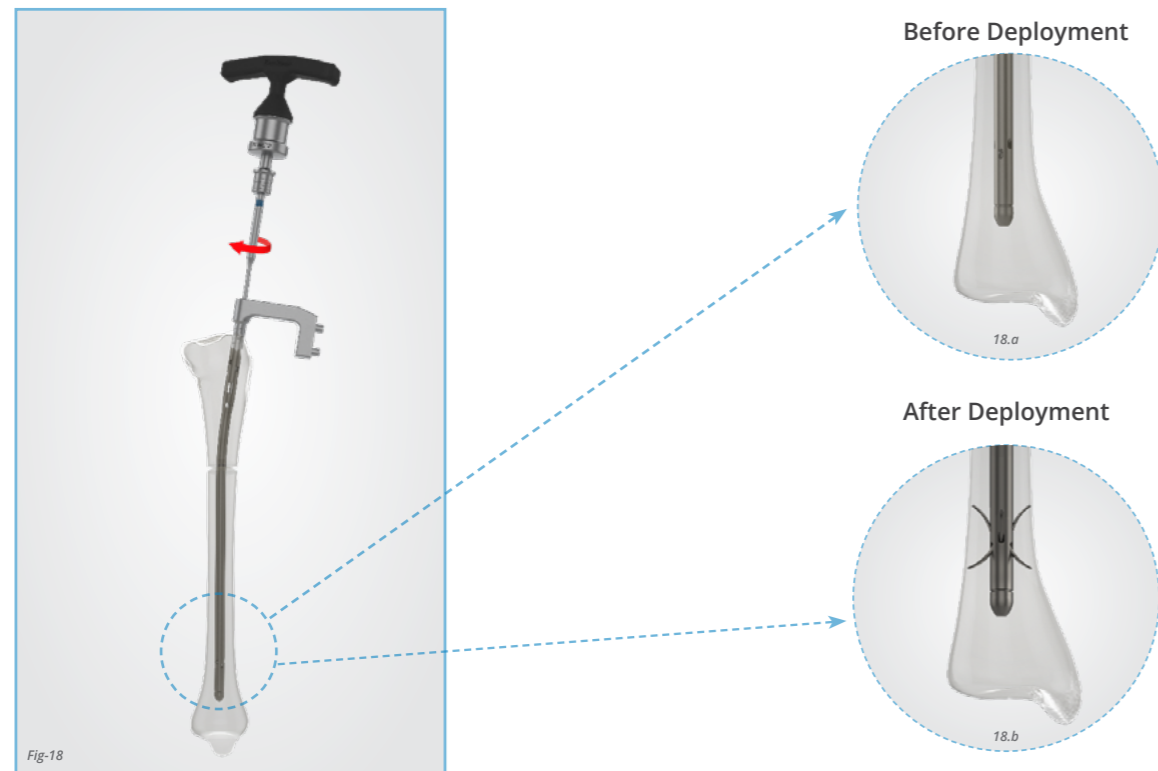

INSTRUMENTS FOR PROXIMAL LOCKING

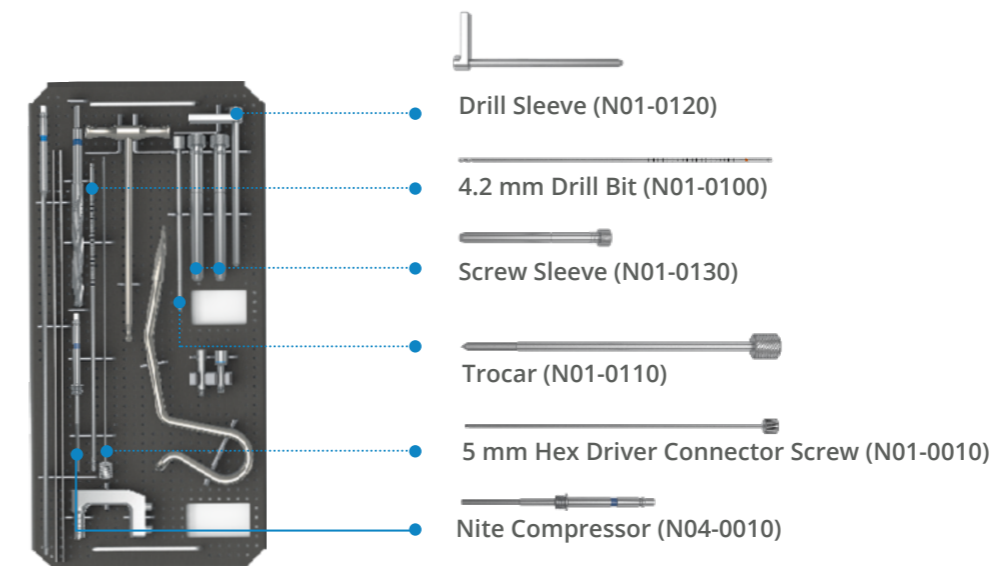

Nite Set Tray 2

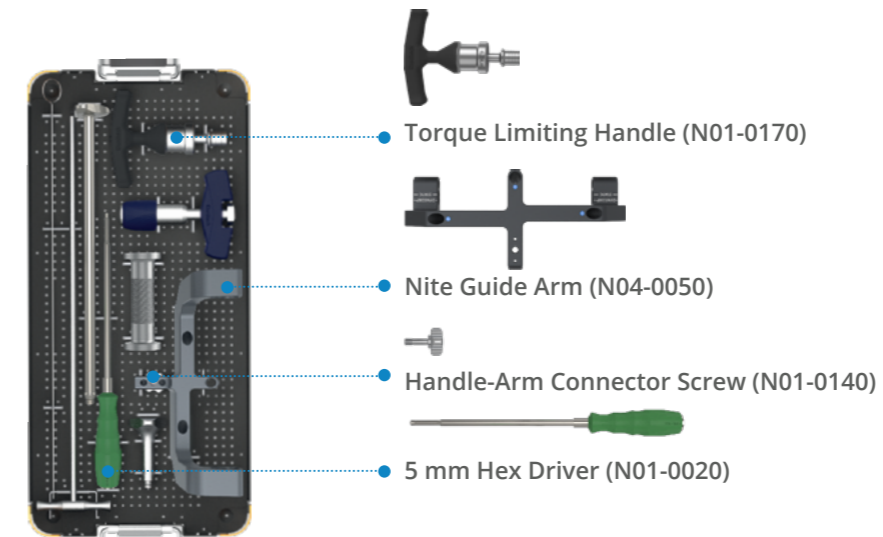

Nite Set Tray 3

Note

- ✓ The Claws cannot be deployed using a powered driver. It may lead to excessive penetration and/or system failure due to over torque.
- ✓ Always use the Torque Limiting Handle.

11. Proximal Locking – Drilling for Locking Screw

INSTRUMENTS:

- ✓ Nite Guide Arm (N04-0050)
- ✓ Handle-Arm Connector Screw (N01-0140)
- ✓ Screw Sleeve (N01-0130)
- ✓ Drill Sleeve (N01-0120)
- ✓ Trocar (N01-0110)
- ✓ 4.2 mm Drill Bit (N01-0100)

- Mate the Nite Guide Arm with the Nite Guide Handle and secure them with the Handle-Arm Connector Screw (Fig-19). Insert the Trocar into the Drill Sleeve and insert them into the Screw Sleeve. Pass the assembly medially through the Dyn/Comp hole in the guide arm, advance it until the skin and make a small incision. Advance the assembly until the Drill Sleeve touches the cortical bone. Apply pressure with the Trocar over the bone to create a dimple in the medial cortex (Fig-20).
- Remove the Trocar and pass the 4.2 mm Drill Bit through the Drill Sleeve. For Compression and Static locking screws, drill through both cortices (Fig-21). For the 3 proximal oblique screws, do not drill the far cortex (posterior aspect of the tibia).
- To decide on the size of the screw to be used, use the marks on the 4.2 mm Drill bit. Position the tip of the bit in the desired position for the screw. For Compression and Static Locking Screws, the tip of the drill will be on the lateral cortex. Make sure that the Drill Sleeve is touching the medial cortex.
- Read the graduation in line with the Drill Sleeve (Fig-21). The measurement will indicate the screw length to be used.



12. Proximal Locking – Inserting the Screw

INSTRUMENTS:

- ✓ 5 mm Hex Driver (N01-0020)
- ✓ 5 mm Hex Driver Connector Screw (N01-0010)

- Mate the 5 mm Hex Driver with the selected screw and secure with the 5 mm Hex Driver Connector Screw (Fig-22). Remove the Drill Sleeve.
- Insert the screw/driver assembly through the Screw Sleeve and into the bone. Advance the screw until its head seats against the medial cortex (Fig-23). Do not over tighten the screw as it may lead to screw stripping.
- Rotate the connector screw counterclockwise to disengage the driver from the screw.

Note

- ✓ If compression is needed, make sure to use a Compression Cortical Screw. It is designed to withstand the compression loads.

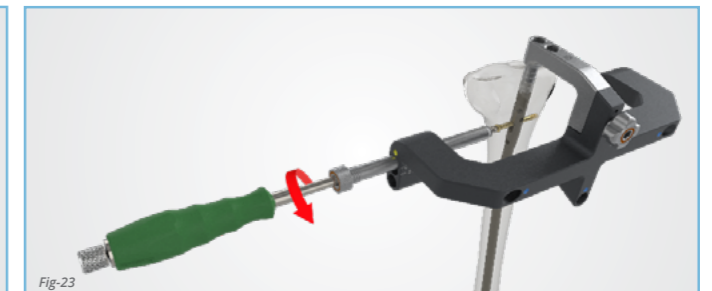

13. Proximal Locking – Compression

INSTRUMENTS:

✓ Torque Limiting Handle (N01-0170)

✓ Nite Compressor (N04-0010)

- Mate the Nite Compressor with the Torque Limiting Handle. Insert the compressor into the Guide Handle and through the nail. Rotate until the compressor engages the thread in the guide handle. Monitor the process with the help of image intensifier.
- As the compressor is rotated, the Compression Cortical Screw is pushed down the dynamic slot and the distal fragment is drawn towards the proximal fragment. Up to 7 mm of compression can be applied (Fig-24).
- Before releasing the compressor, insert a Cortical Screw in the static hole to ensure that the compression will be maintained (Fig-25).

Note

- ✓ Do not over compress as it may cause the screw to fail. Do not backslap the nail against the deployed Claws to achieve compression.

- If necessary, insert the oblique screws by following the same procedure in the previous sections (Fig-26).

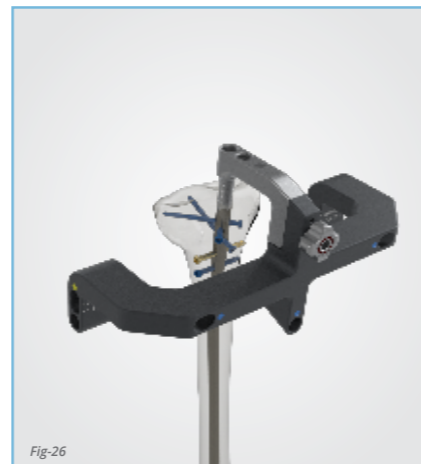

INSTRUMENTS FOR INSERTING END CAP

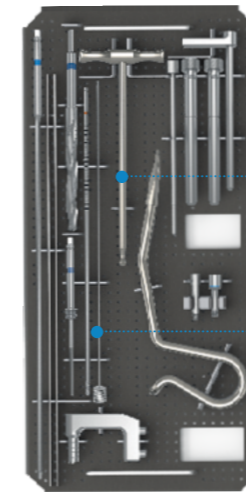

Nite Set Tray 2



7 mm Hex Driver (N01-0030)



5 mm Hex Driver Connector Screw (N01-0010)

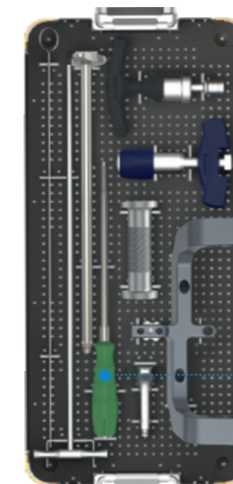

Nite Set Tray 3



5 mm Hex Driver (N01-0020)

14. Inserting End Cap

INSTRUMENTS:

- ✓ 7 mm Hex Driver (N01-0030)
 - ✓ 5 mm Hex Driver (N01-0020)
 - ✓ 5 mm Hex Driver Connector Screw (N01-0010)
- Check the final nail head position, it may have changed if compression was applied. The rings in the handle are spaced 5 mm from each other, they indicate the depth of the nail's head.
 - If satisfied with the final implant's position, remove the Screw Sleeve and use the 7 mm Hex Driver to release the nail from the Guide Handle.
 - Mate the 5 mm Hex Driver to the chosen end cap and secure with the 5 mm Hex Driver Connector Screw (Fig-27). Pass the end cap/driver assembly through the incision and mate with the proximal end of the nail, rotating clockwise with the driver until it is fully threaded.
 - Rotate the connector screw counterclockwise to disengage the driver from the end cap (Fig-28).

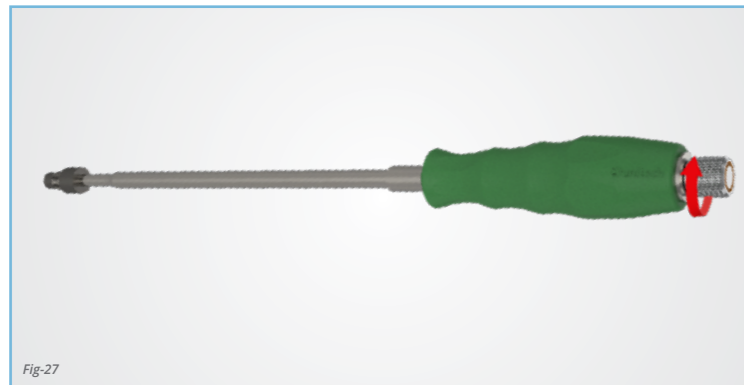

Nail Removal

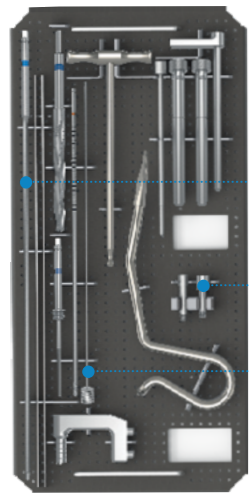

Nite Set Tray 2

- Nite Claw Deployment Driver (N04-0020)
- Nite Extractor Connector (N04-0040)
- 5 mm Hex Driver Connector Screw (N01-0010)

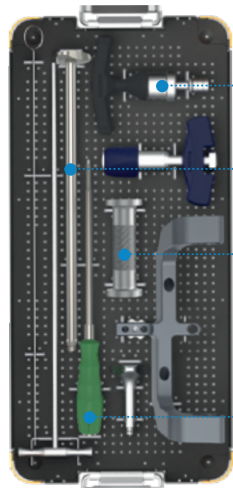

Nite Set Tray 3

- Torque Limiting Handle (N01-0170)
- Extractor (N01-0050)
- Slide Hammer (N01-0160)
- 5 mm Hex Driver (N01-0020)

1. Removing Nail End Cap

INSTRUMENTS:

- ✓ 5 mm Hex Driver (N01-0020)
- ✓ 5 mm Hex Driver Connector Screw (N01-0010)
- Insert the 5 mm Hex Driver Connector screw into the 5 mm Hex Driver and mate the driver to the nail end cap. Rotate the connector screw clockwise to secure the end cap to the driver. Rotate the driver counterclockwise until the end cap is fully released (Fig-29).



Fig-29

2. Removing the Cortical Screws

INSTRUMENTS:

- ✓ 5 mm Hex Driver (N01-0020)
- ✓ 5 mm Hex Driver Connector Screw (N01-0010)
- Insert the 5 mm Hex Driver Connector screw into the 5 mm Hex Driver and mate the driver to the cortical screw.
- Rotate the connector screw clockwise to secure the cortical screw to the driver.
- Remove the cortical screw by rotating the driver counterclockwise (Fig-30).
- Ensure all screws have been removed before proceeding.

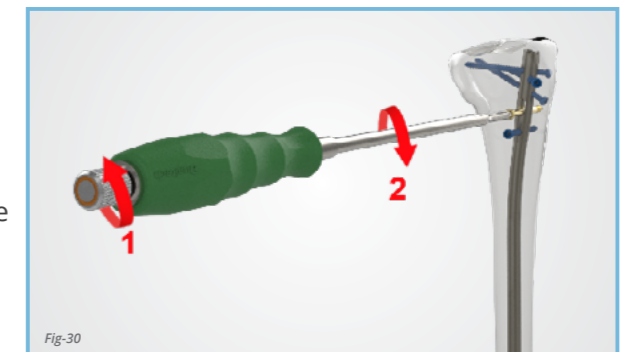
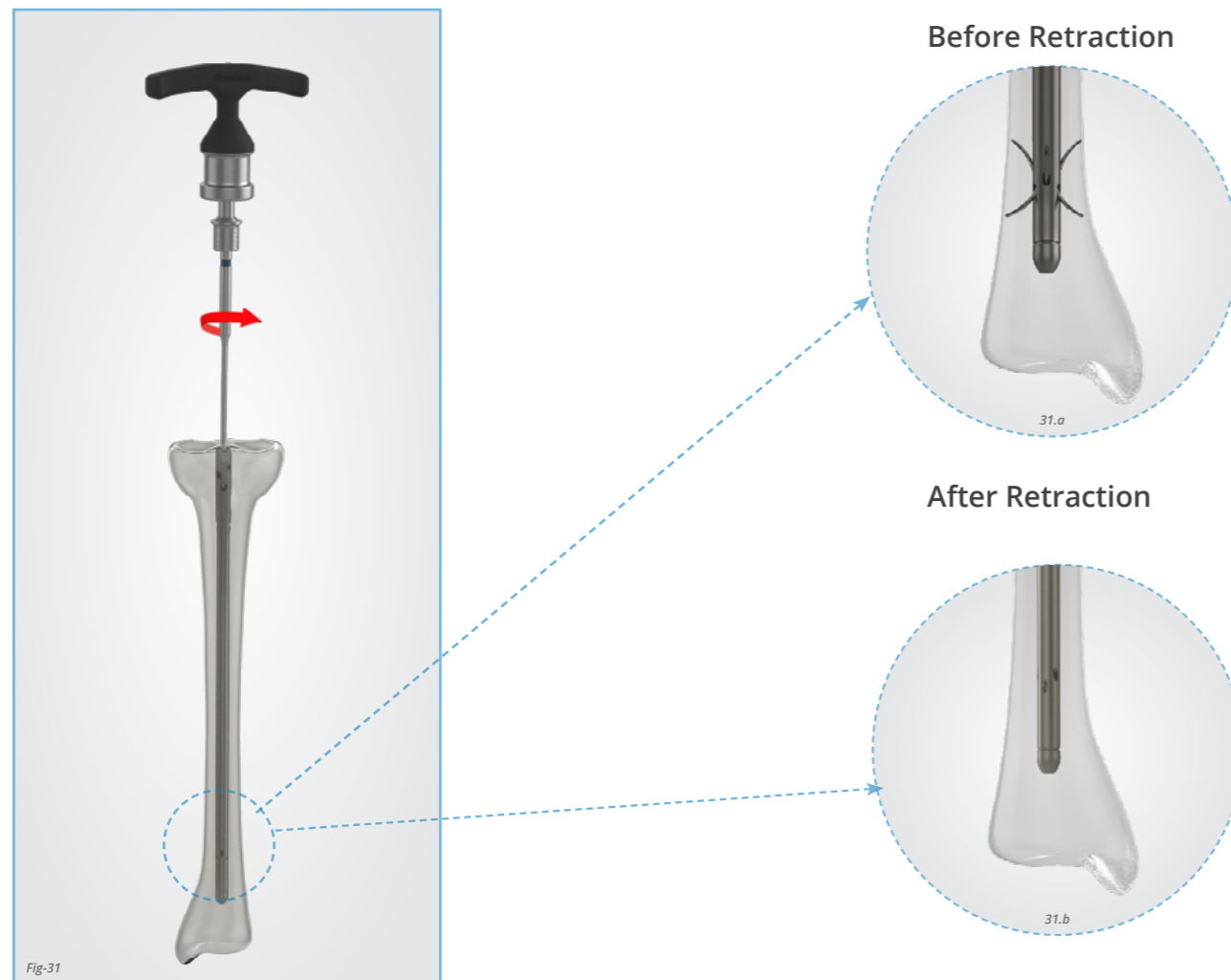

Fig-30

3. Retracting Nail Claws

INSTRUMENTS:

- ✓ Nite Claw Deployment Driver (N04-0020)
 - ✓ Torque Limiting Handle (N01-0170)
 - ✓ Distal Claw Deployment Driver – Long (N02-0220) - Optional (if using the Revision Set)
 - ✓ T Extraction Handle (N01-0320) - Optional (if using the Revision Set)
- Attach the appropriate Nite Claw Deployment Driver or Distal Claw Deployment Driver – Long to the Torque Limiting Handle or T Extraction Handle.
 - Insert the driver down the nail until it engages the distal Claw mechanism.
 - Rotate the handle counterclockwise to retract the Claws. A fully deployed Claw mechanism would need 18 turns to be completely retracted but the amount of turns necessary will depend on how much the Claws had been deployed (Fig-31).
 - Confirm the full retraction radiographically.



4. Removing the Nail

INSTRUMENTS:

- ✓ Extractor (N01-0050)
 - ✓ Slide Hammer (N01-0160)
 - ✓ Nite Extractor Connector (N04-0040)
- Attach the Nite Extractor Connector into Extractor and pass the Slide Hammer over it (Fig-32). Mate the Nite Extractor Connector with the nail and rotate the Extractor clockwise to secure the assembly to the nail. With gentle blows of the Slide Hammer, remove the nail from the femur (Fig-33).

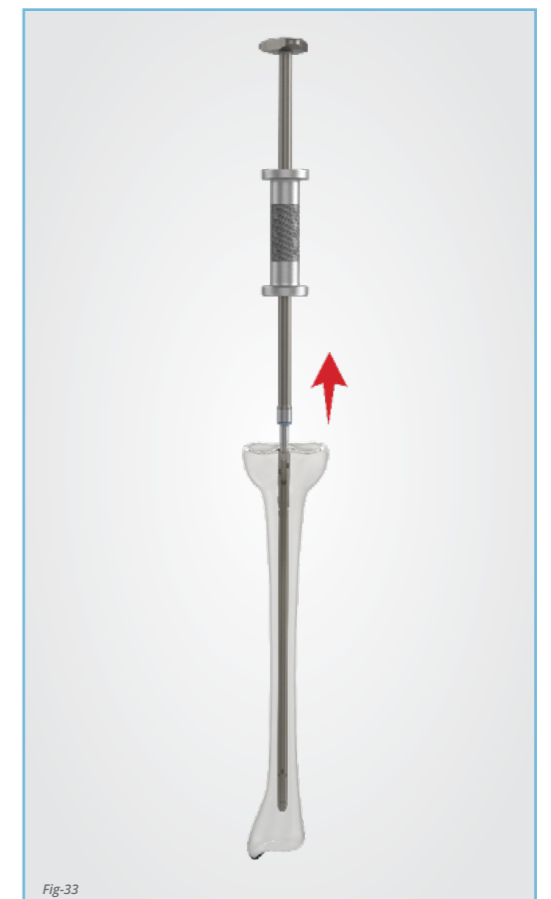

Correct Use of the Flexible Shaft

The Nite Claw Deployment Driver has a flexible shaft. The more the shaft is flexed, the less torque it can deliver before permanently deforming.

To ensure a continued functionality of the instrument, the shaft should be returned to a straight orientation when significant resistance is felt.

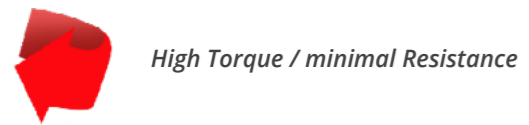

High Torque / minimal Resistance



Low Torque / Significant Resistance

Catalogue Information

Nite Tibial Nail

Distal Diameter	Length (mm)	Catalogue Code
-----------------	-------------	----------------

9	270	NITE-09-270
9	285	NITE-09-285
9	300	NITE-09-300
9	315	NITE-09-315
9	330	NITE-09-330
9	345	NITE-09-345
9	360	NITE-09-360
9	375	NITE-09-375
10	270	NITE-10-270
10	285	NITE-10-285
10	300	NITE-10-300
10	315	NITE-10-315
10	330	NITE-10-330
10	345	NITE-10-345
10	360	NITE-10-360
10	375	NITE-10-375
11	270	NITE-11-270
11	285	NITE-11-285
11	300	NITE-11-300
11	315	NITE-11-315
11	330	NITE-11-330
11	345	NITE-11-345
11	360	NITE-11-360
11	375	NITE-11-375



End Caps

Extension (mm)	Catalogue Code
----------------	----------------

0 (flush)	NITE-11-000
5	NITE-11-005
10	NITE-11-010
15	NITE-11-015
20	NITE-11-020



Cortical Screws

Diameter (mm)	Length (mm)	Catalogue Code
---------------	-------------	----------------

5	30	CORS-05-030
5	35	CORS-05-035
5	40	CORS-05-040
5	45	CORS-05-045
5	50	CORS-05-050
5	55	CORS-05-055
5	60	CORS-05-060
5	65	CORS-05-065
5	70	CORS-05-070
5	75	CORS-05-075
5	80	CORS-05-080
5	85	CORS-05-085
5	90	CORS-05-090
5	95	CORS-05-095
5	100	CORS-05-100
5	105	CORS-05-105
5	110	CORS-05-110
5	115	CORS-05-115
5	120	CORS-05-120

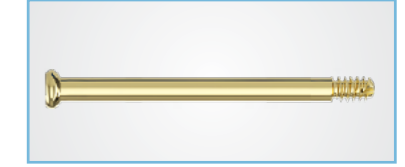

Compression Cortical Screws

Diameter (mm)	Length (mm)	Catalogue Code
---------------	-------------	----------------

5	30	COMS-05-030
5	35	COMS-05-035
5	40	COMS-05-040
5	45	COMS-05-045
5	50	COMS-05-050
5	55	COMS-05-055
5	60	COMS-05-060
5	65	COMS-05-065
5	70	COMS-05-070
5	75	COMS-05-075
5	80	COMS-05-080
5	85	COMS-05-085
5	90	COMS-05-090
5	95	COMS-05-095
5	100	COMS-05-100
5	105	COMS-05-105
5	110	COMS-05-110
5	115	COMS-05-115
5	120	COMS-05-120

Nite Tool Set

- Nite Tray 1
- Nite Tray 2
- Nite Tray 3

Nite Tray 1

N01-0150
TISSUE PROTECTOR

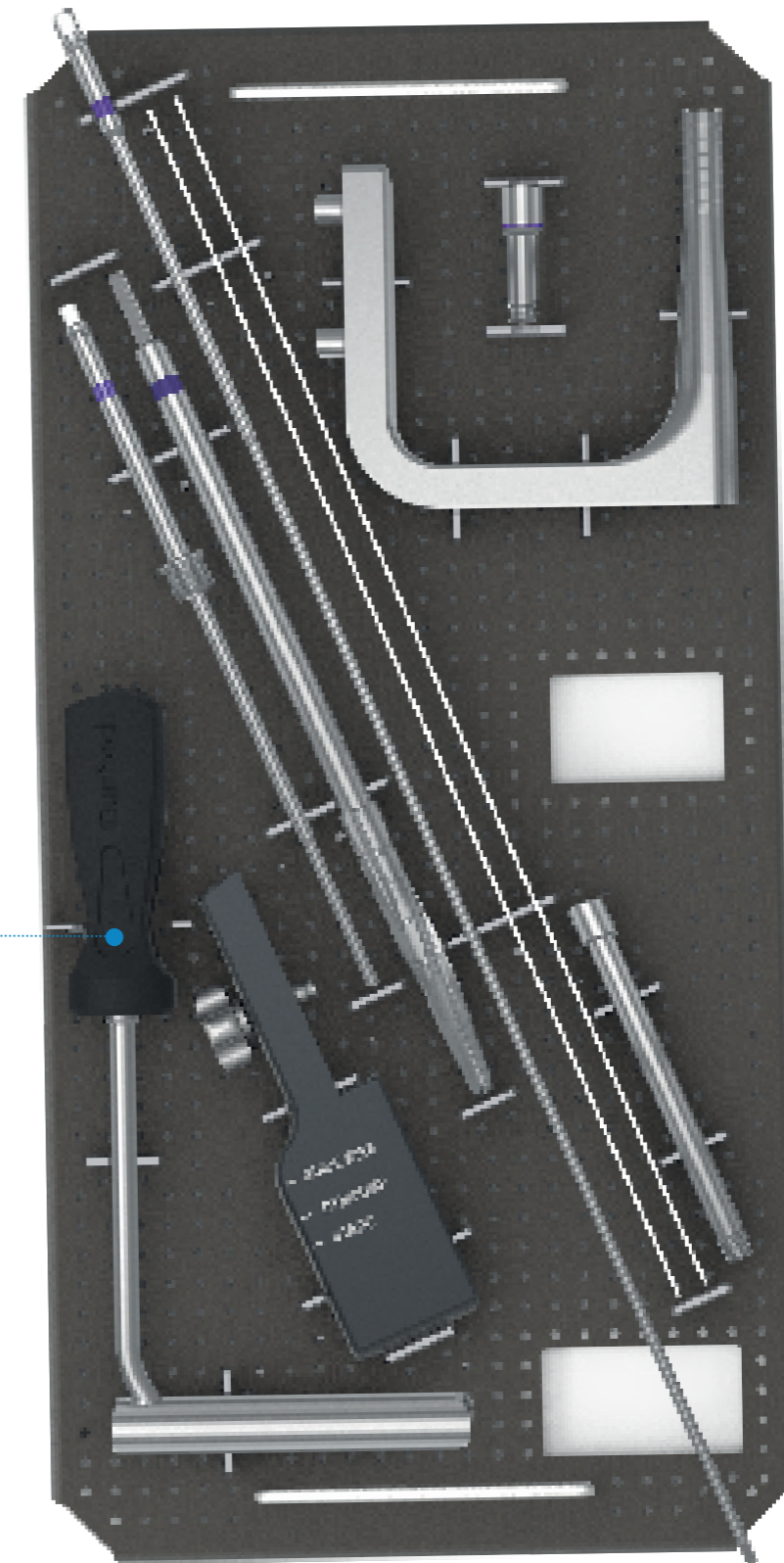

Nite Tray 2

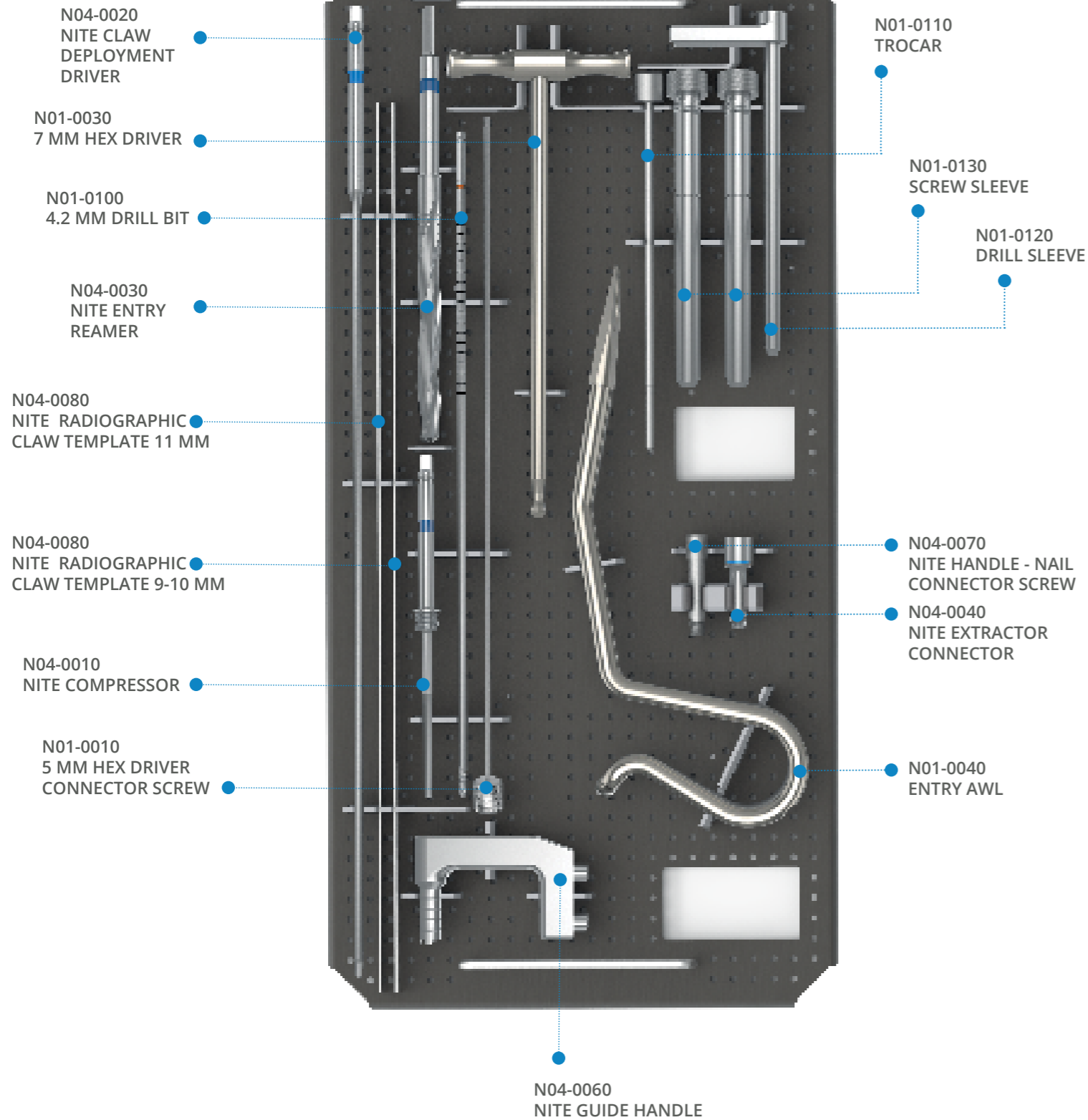

Nite Tray 3

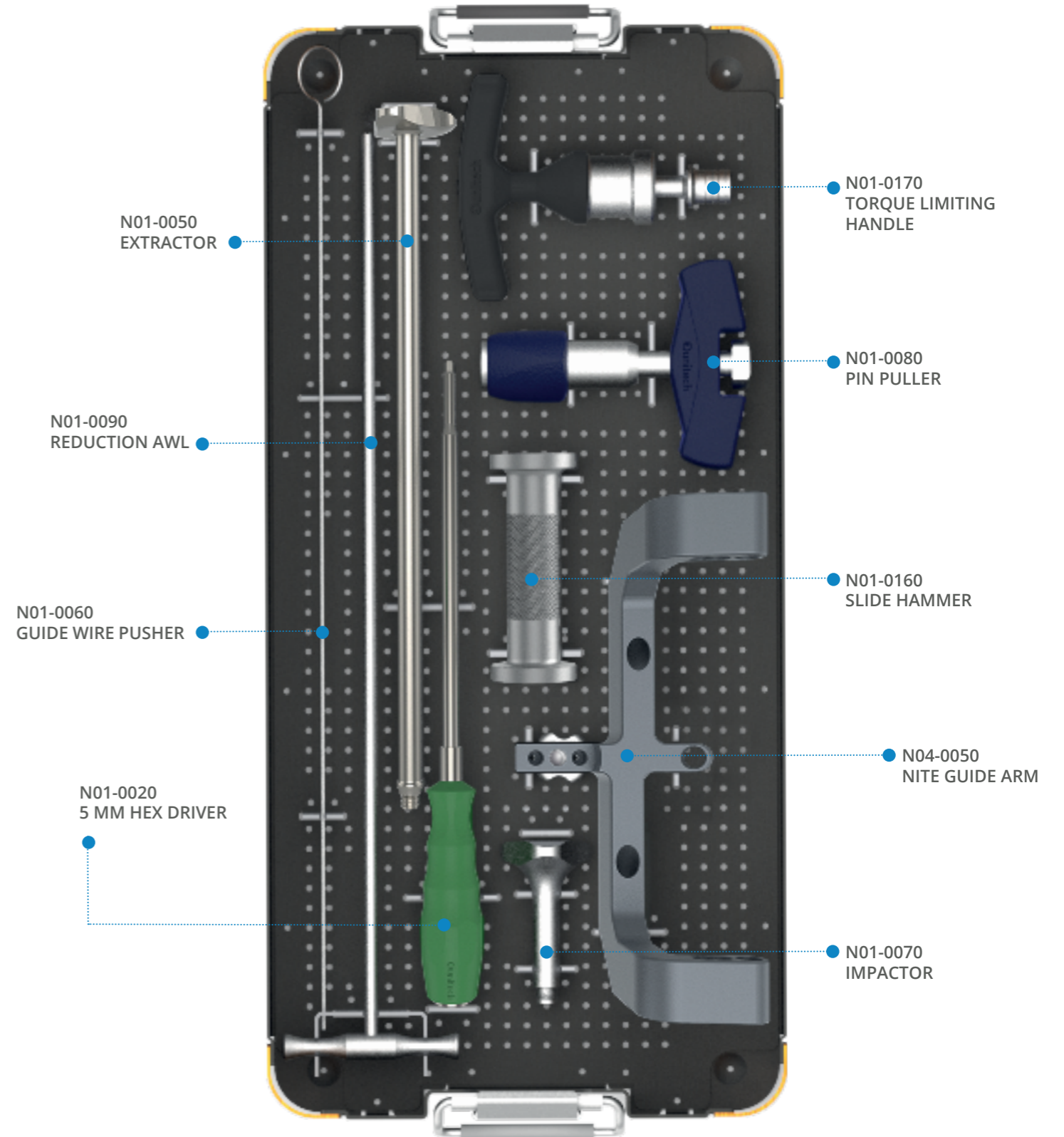

NOTES

Product availability is subject to the regulatory and/or medical practices in individual markets. Some or all products described in those documents may not be available in your region. Please contact your Dunitech representative for information regarding product availability in your area.

Dunitech is a registered Oliga brand.

OLIGA MAKINA ELEKTRONIK SANAYI LTD. STI.
İvedik OSB Mh. 1453 Cd. No: 5/D 06378 Yenimahalle, Ankara / TURKEY
+90 312 220 1577 info@oliga.com.tr / www.oliga.com.tr



www.duni-tech.com